



RIPRIDER™ 360° **CASTER TRIKE**



OWNER'S MANUAL

**Read and understand this entire manual before riding!
For assistance contact Razor. DO NOT RETURN TO STORE.**

Item Number:
20036540

CONTENTS

Safety Warnings	1	RipRider 360° Caster Trike Parts	5
Before You Begin.....	2	Safety Reminders.....	6
Assembly and Set-Up.....	3-4	Warranty	6

SAFETY WARNINGS

⚠ WARNING: Riding the RipRider 360° Caster Trike can be a hazardous activity. Certain conditions may cause the equipment to fail without fault of the manufacturer. The RipRider 360° Caster Trike can and is intended to move, and it is therefore possible to lose control, fall off and/or get into dangerous situations that no amount of care, instruction or expertise can eliminate. If such things occur you can be seriously injured or die, even when using safety equipment and other precautions. **RIDE AT YOUR OWN RISK AND USE COMMON SENSE.**

This manual contains many warnings and cautions concerning the consequences of failing to maintain, inspect or properly use your RipRider 360° Caster Trike. Because any incident can result in serious injury or even death, we do not repeat the warning of potential serious injury or death each time such a possibility is mentioned.

APPROPRIATE RIDER USE AND PARENTAL SUPERVISION

This manual contains important safety information. It is your responsibility to review this information and make sure that all riders understand all warnings, cautions, instructions and safety topics and assure that young riders are able to safely and responsibly use this product. Razor recommends that you periodically review and reinforce the information in this manual with younger riders, and that you inspect and maintain your children's RipRider 360° to insure their safety.

The recommended rider age of 5 and older for RipRider 360° Caster Trike is only an estimate, and can be affected by the rider's size, weight or skills. Any rider unable to fit comfortably on the RipRider 360° Caster Trike should not attempt to ride it. **A parent's decision to allow his or her child to ride this product should be based on the child's maturity, skill and ability to follow rules.**

Keep this product away from small children and remember that this product is intended for use only by persons who are, at a minimum, completely comfortable and competent while operating the RipRider 360°.

DO NOT EXCEED THE WEIGHT LIMIT OF 160 pounds. Rider weight does not necessarily mean a person's size is appropriate to fit or maintain control of the RipRider 360° Caster Trike.

ACCEPTABLE RIDING PRACTICES AND CONDITIONS

Always check and obey any local laws or regulations which may affect the locations where the RipRider 360° Caster Trike may be used on public property. The RipRider 360° Caster Trike is meant to be used only in controlled environments free of potential traffic hazards and not on public streets. Do not ride your RipRider 360° Caster Trike in any areas where pedestrian or vehicle traffic is present.

Ride defensively. Watch out for potential obstacles that could force you to swerve suddenly or lose control. Be careful to avoid pedestrians, skaters, skateboards, scooters, bikes, children or animals who may enter your path, and respect the rights and property of others.

Maintain a hold on the handlebars at all times.

Never carry passengers or allow more than one person at a time to ride the RipRider 360° Caster Trike.

Never use near steps or swimming pools.

Never use headphones or a cell phone when riding.

Never hitch a ride with another vehicle.

The RipRider 360° Caster Trike is intended for use on solid, flat, clean and dry surfaces such as pavement or level ground without loose debris such as rocks or gravel. Wet, slick or uneven and rough surfaces may impair traction and contribute to possible accidents. Do not ride the RipRider 360° Caster Trike in mud, ice, puddles or water. Avoid excessive speeds that can be associated with downhill rides. Never risk damaging surfaces such as carpet or flooring by use of a RipRider 360° Caster Trike indoors.

Do not ride at night or when visibility is impaired.

PROPER RIDING ATTIRE

Always wear proper protective equipment such as an approved safety helmet. Elbow pads and kneepads are recommended. A helmet may be legally required by local law or regulation in your area. Always wear shoes, never ride barefooted or in sandals, and keep shoelaces tied and out of the way of the wheels.

FAILURE TO USE COMMON SENSE AND HEED THE ABOVE WARNINGS INCREASES RISK OF SERIOUS INJURY. USE WITH APPROPRIATE CAUTION AND SERIOUS ATTENTION TO SAFE OPERATION.

BEFORE YOU BEGIN

Remove contents from box and check parts against part diagram below. Remove the foam separators that protect the components from damage during shipping. Inspect the contents of the box for scratches in the paint, or dents that may have occurred during shipping. Because the Rip Rider 360° was partially assembled and packed at the factory, there should not be any problems, even if the box has a few scars or dents.

Estimated Assembly and Set-Up Time

Razor recommends assembly by an adult with experience in bicycle mechanics. Allow up to 15–20 minutes for assembly.

WARNING: DO NOT USE NON-RAZOR PRODUCTS WITH YOUR RIPRIDER 360°.

The RipRider 360° has been built to certain Razor design specifications. The original equipment supplied at the time of sale was selected on the basis of its compatibility with the frame, fork and all other parts. Certain aftermarket products may or may not be compatible.

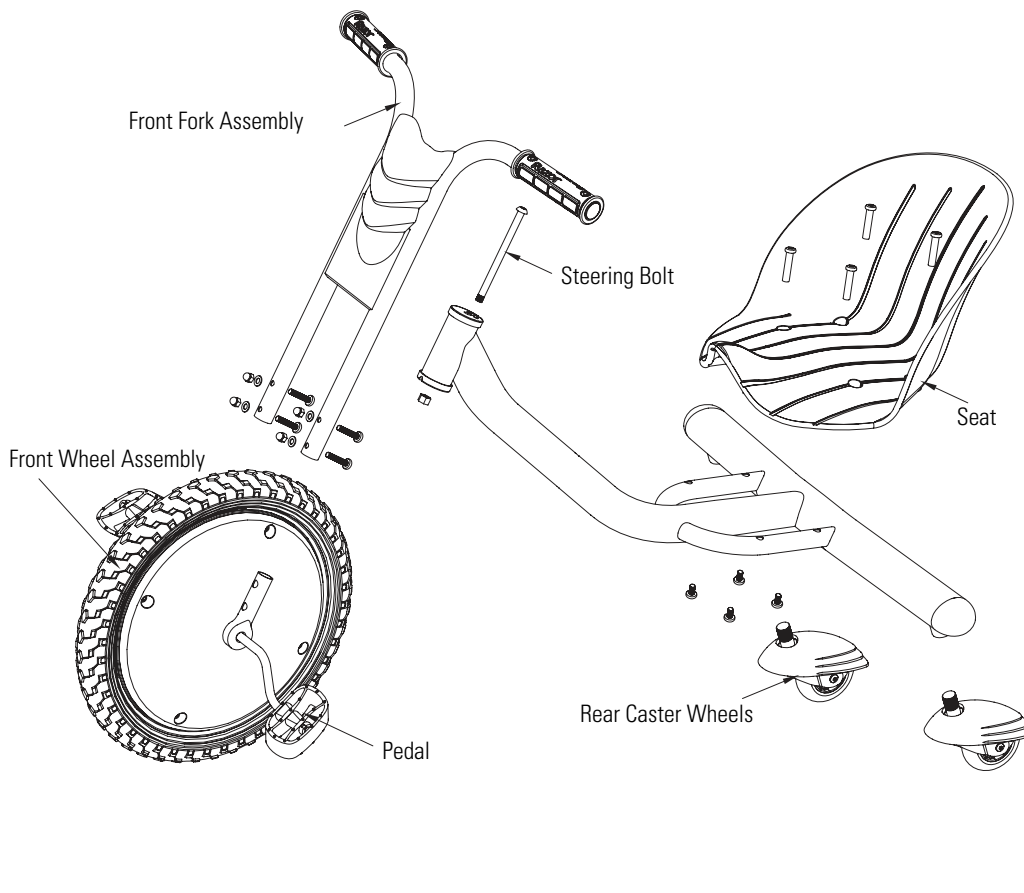

Required Tools

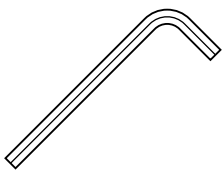

(2) 5mm
allen wrenches
(included)

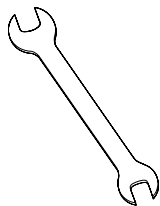

10mm and 13mm
open wrenches
(included)

Need Help? Visit our web site for replacement parts, product support and a list of authorized service centers at www.razor.com or call toll-free at 866-467-2967 Monday - Friday 8:00 AM - 5:00 PM Pacific Time.

ASSEMBLY AND SET-UP

□ Attaching the Front Fork

Required Tools: 13mm open wrench and 5mm allen wrench

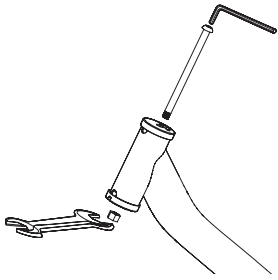

1 Remove the steering bolt and locknut from the frame assembly with a 13mm open wrench and 5mm allen wrench.

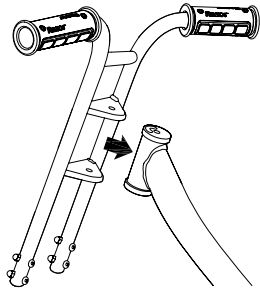

2 Insert the front fork into the frame assembly.

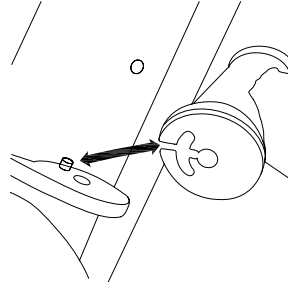

3 Be sure to properly align slot in headset tube with pin on fork as shown.

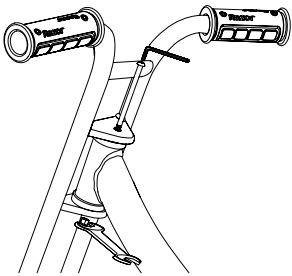

4 Re-insert the steering bolt and secure with locknut using a 13mm open wrench and 5mm allen wrench.

□ Attaching the Front Wheel

Required Tools: 5mm allen wrench and 10mm open wrench

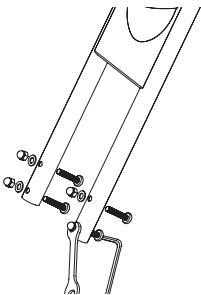

1 Remove the four coupling bolts from the front fork with a 5mm allen wrench and 10mm open wrench.

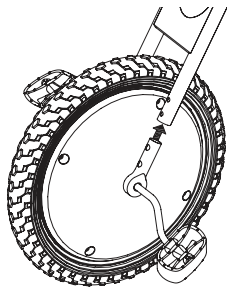

2 Insert the wheel assembly into the front fork assembly and align holes.

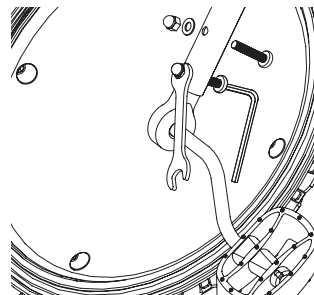

3 Re-insert the coupling bolts through the front fork and secure with allen wrench and open wrench.

⚠ WARNING: Failing to properly tighten the steering bolt that attaches the handlebars can cause you to lose control and fall.

ASSEMBLY AND SET-UP

□ Attaching the Rear Caster Wheels

Required Tools: 5mm allen wrench

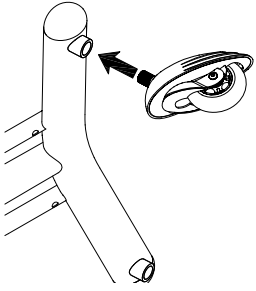

1 Locate the threaded hole on the rear underside of the frame. Screw caster wheel into hole.

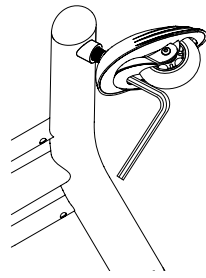

2 Tighten with 5mm allen wrench.

□ Attaching the Seat

Required Tools: (2) 5mm allen wrench

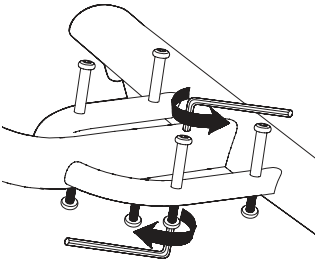

1 Remove the four coupling bolts from the frame using two 5mm allen wrenches. One on top and one on bottom.

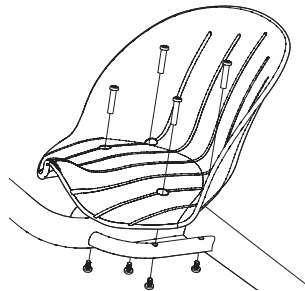

2 Align four holes in seat with four holes in frame. Insert coupling bolts through the top and bottom of the frame.

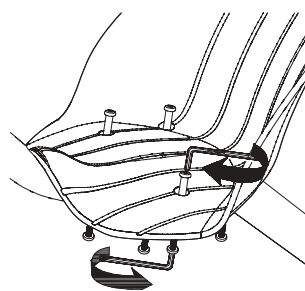

3 Tighten bolts using two 5mm allen wrenches. One on top and one on bottom.

RIPRIDER 360° CASTER TRIKE PARTS

Keep your RipRider 360° running for years with genuine Razor parts. Visit our web site to purchase replacement parts.
(Specifications subject to change without notice.)

- | | | | |
|---|----------------|---|-------------------------|
| 1 | Handlebar Grip | 5 | Lock Nut |
| 2 | Front Fork | 6 | Front Wheel Complete |
| 3 | Front Cover | 7 | 75mm Rear Caster Wheels |
| 4 | Steering Bolt | 8 | Seat |

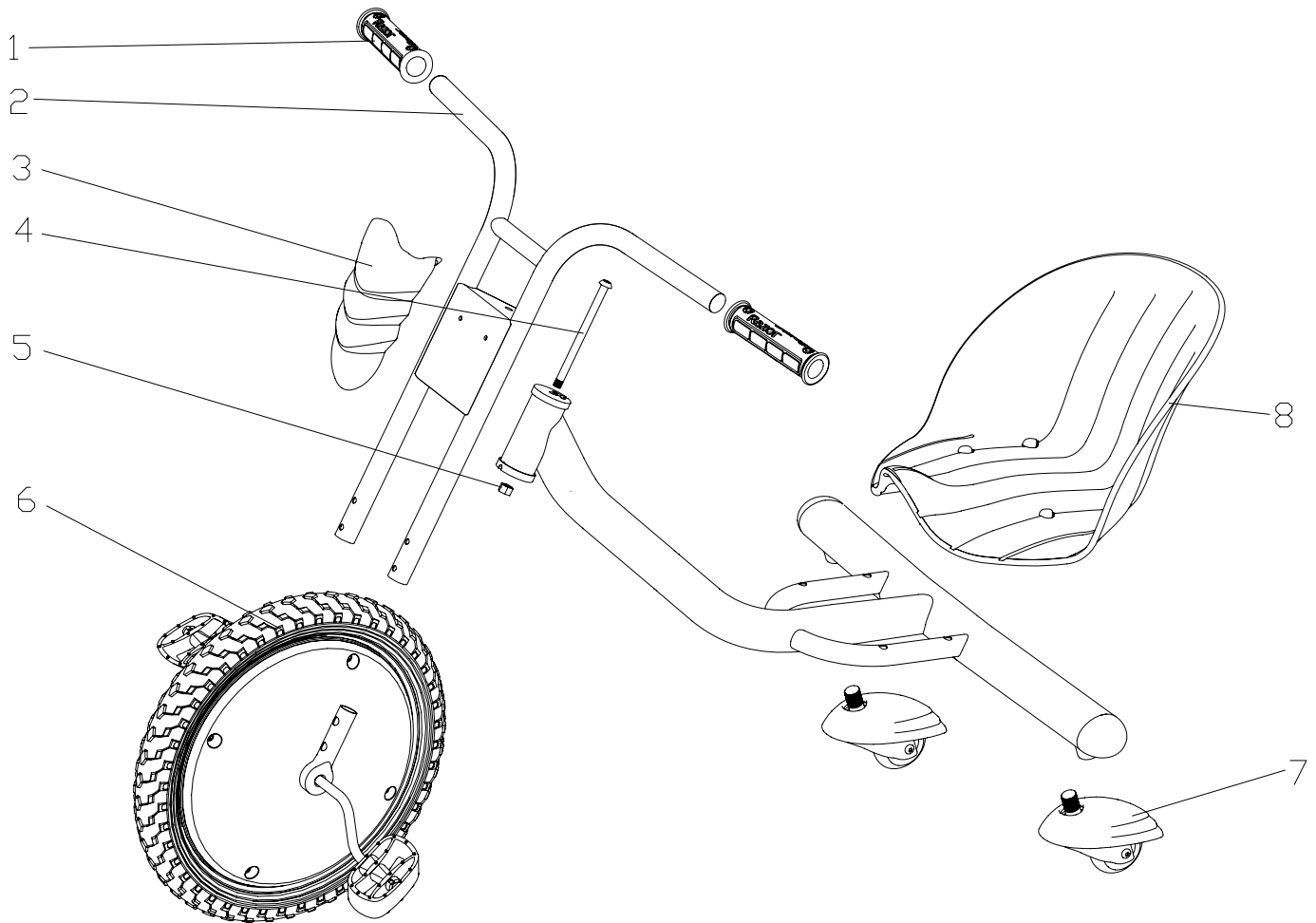

SAFETY REMINDERS

PRE-RIDE CHECKLIST



Loose Parts

Check and secure all fasteners before every ride. Make sure the steering bolt and casters are tight. There should not be any unusual rattles or sounds from loose parts or broken components. If you are not sure, ask an experienced mechanic to check.



Frame, Fork and Handlebars

Check for cracks or broken connections. Although broken frames are rare, it is possible for an aggressive rider to crash into a curb or wall and wreck and bend or break a frame. Get in the habit of inspecting yours regularly.



Tire Care

Periodically inspect the tire for excess wear.



Safety Gear

Always wear proper protective equipment such as an approved safety helmet. Elbow pads and kneepads are recommended. Always wear shoes (lace-up shoes with rubber soles), never ride barefooted or in sandals, and keep shoelaces tied and out of the way of the wheels.

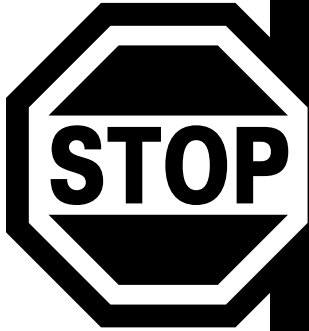

DO NOT RETURN TO STORE

Do not use this product for the first time until you have inflated the tires to the correct PSI.

Failure to follow these instructions may damage your product and void your warranty.

WARRANTY

Razor Limited Warranty

The manufacturer warrants this product to be free of manufacturing defects for a period of 6 months from date of purchase. This Limited Warranty does not cover normal wear and tear, tire, or any damage, failure or loss caused by improper assembly, maintenance, or storage or use of the Razor RipRider 360°.

This Limited Warranty will be void if the product is ever

- used in a manner other than for recreation;
- modified in any way;
- rented.

The manufacturer is not liable for incidental or consequential loss or damage due directly or indirectly to the use of this product.

Razor does not offer an extended warranty. If you have purchased an

extended warranty, it must be honored by the store at which it was purchased.

For your records, save your original sales receipt with this manual.

Item Number:

20036540

Need Help? Visit our web site for replacement parts, product support and a list of authorized service centers at www.razor.com or call toll-free at 866-467-2967 Monday - Friday 8:00 AM - 5:00 PM Pacific Time.

