



Siege™ Caster Scooter



OWNER'S MANUAL

**Read and understand this entire manual before
allowing child to use this product!**

For assistance contact Razor. DO NOT RETURN TO STORE.

NOTE: Manual illustrations are for demonstration purposes only. Illustrations may not reflect exact appearance of actual product. Specifications subject to change without notice.

**For warranty assistance, please contact
Razor at 866-467-2967**

CONTENTS

Safety Warnings	1	Caster Scooter Parts List	5
Before You Begin.....	2	Safety Tips	6
Set Up and Usage Instructions.....	3	Warranty	6
Check Before Riding.....	4		

SAFETY WARNINGS

⚠ AN IMPORTANT MESSAGE TO PARENTS: This manual contains important information. For your child's safety, it is your responsibility to review this information with your child and make sure that your child understands all warnings, cautions, instructions and safety topics. Razor USA recommends that you periodically review and reinforce the information in this manual with younger riders and that you are required to inspect and maintain your child's caster scooter to insure their safety.

⚠ GENERAL WARNING: Caster scooter riding can be a hazardous activity. Caster scooters can and are intended to move and it is therefore possible to get into dangerous situations and/or lose control and/or fall. If such things occur you can be seriously injured or die. LIKE ANY OTHER MOVING PRODUCT, USING A CASTER SCOOTER CAN BE A DANGEROUS ACTIVITY AND MAY RESULT IN INJURY OR DEATH EVEN WHEN USED WITH PROPER SAFETY PRECAUTIONS. USE AT YOUR OWN RISK AND USE COMMON SENSE.

- Always wear safety equipment such as a helmet, knee pads and elbow pads. Always wear a helmet when riding your caster scooter and keep the chinstrap securely buckled.
- Always wear shoes.
- Ride on smooth, paved surfaces away from motor vehicles.
- Avoid sharp bumps, drainage grates and sudden surface changes. Caster scooter may suddenly stop.
- Avoid streets and surfaces with water, sand, gravel, dirt, leaves and other debris. Wet weather impairs traction, braking and visibility.
- Do not ride at night.
- Avoid excessive speed associated with downhill rides.
- Adults must assist children in the initial adjustment procedures to unfold scooter, adjust handlebar and steering height and finally to fold scooter.
- Obey all local traffic and scootering laws and regulations.
- Watch out for pedestrians.
- Do not exceed 143lbs (65 kgs) total weight on the caster scooter.
- Do not allow children under age eight (8) to use the caster scooter. All children and preteens should ride with adult supervision at all times.
- Rider weight does not necessarily mean a child's size is appropriate to fit or maintain control of the caster scooter.
- The skill required to ride this product may be greater than that required to ride a traditional kick scooter.
- A parent's decision to allow his or her child to ride this product should be based on the child's maturity, skill and ability.
- Refer to the section on safety for additional warnings.

ACCEPTABLE RIDING PRACTICES AND CONDITIONS

Direct parental supervision is required. Caster scooters are meant to be used only in controlled environments free of potential traffic hazards and not on public streets. Do not allow your child to ride a caster scooter in any areas where vehicle traffic is present. The child must maintain a hold on the handlebars at all times. Never allow more than one child at a time to ride a caster scooter. Never use near steps, sloped driveways, hills, roadways, alleys or swimming pool areas. Keep fingers and other body parts away from the product when folding or unfolding. Adults must not allow children to assist in folding or unfolding the caster scooter.

Do not ride a caster scooter in wet weather. Caster scooters are intended for use on solid, flat, clean and dry surfaces such as pavement or level ground without loose debris such as rocks or gravel. Wet, slick or uneven and rough surfaces may impair traction and contribute to possible accidents. Do not ride a caster scooter in mud, ice, puddles or water. Avoid excessive speeds that can be associated with downhill rides. Never risk damaging surfaces such as carpet or flooring by use of a caster scooter indoors. Do not ride at night or when visibility is impaired.

PROPER RIDING ATTIRE

Always ensure child is wearing proper protective equipment such as an approved safety helmet. A helmet may be legally required by local law or regulation in your area. A child should always wear shoes, never ride barefooted or in sandals and should keep shoelaces tied and out of the way of the wheels.

FAILURE TO USE COMMON SENSE AND HEED THE ABOVE WARNINGS FURTHER INCREASES RISK OF SERIOUS INJURY. USE AT YOUR OWN RISK AND WITH APPROPRIATE AND SERIOUS ATTENTION TO SAFE OPERATION. USE CAUTION.

⚠ WARNING: ALWAYS INSPECT THE CASTER SCOOTER PRIOR TO RIDING. Properly inspecting and maintaining your caster scooter can reduce the risk of injury. Always inspect your caster scooter before riding and regularly maintain it.

⚠ WARNING: CHECK LOCAL LAWS REGARDING CASTER SCOOTER USE. Check local laws and regulations to see where and how you may use your Razor caster scooter legally. In many states and local areas caster scooter riders are required BY LAW to wear a helmet. Check local laws and regulations regarding laws governing helmet use and caster scooter operation in your area.

BEFORE YOU BEGIN

Remove contents from box. Remove the foam separators that protect the components from damage during shipping. Inspect the contents of the box for scratches in the paint and dents that may have occurred during shipping. Because your caster scooter was assembled and packed at the factory, there should not be any problems, even if the box has a few scars or dents.

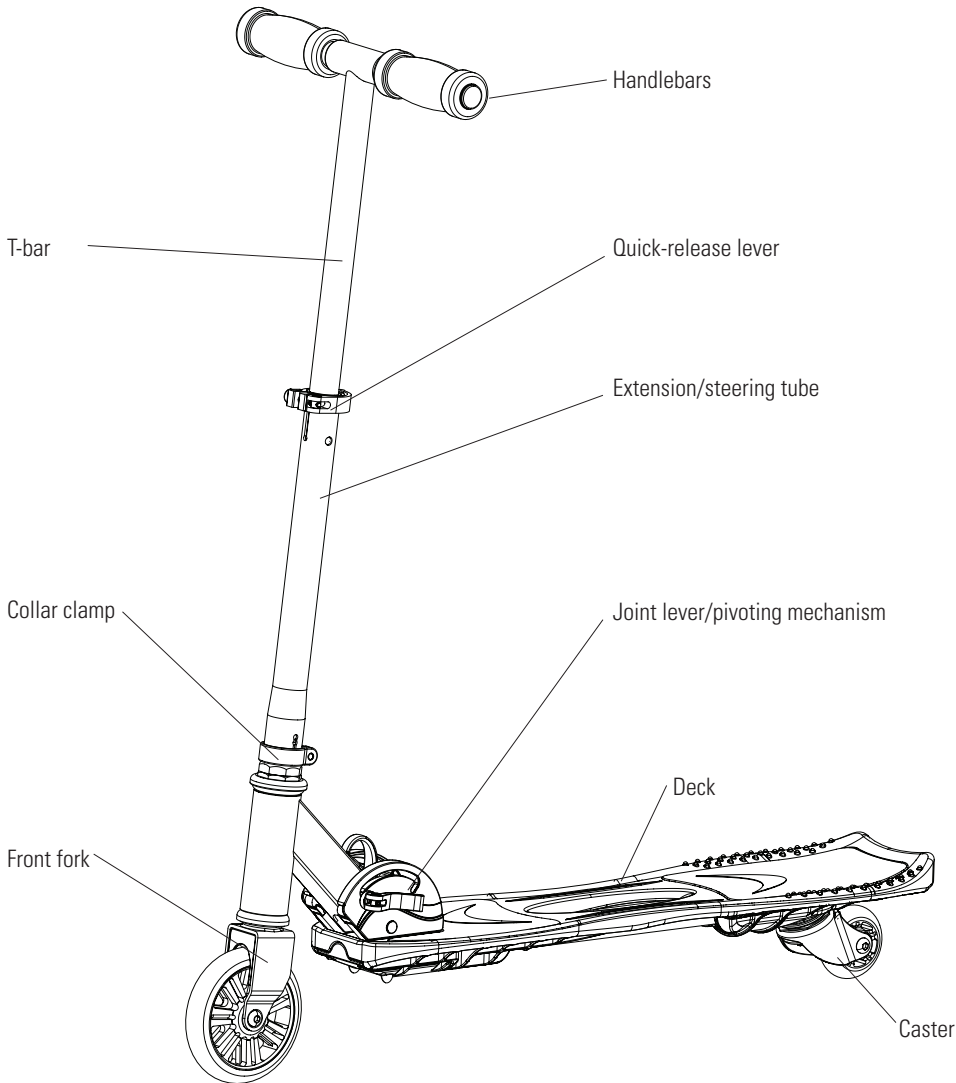

□ Required Tools

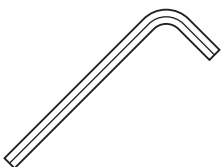

3mm & 5mm
allen wrench

⚠ WARNING: DO NOT USE NON-RAZOR PRODUCTS WITH YOUR CASTER SCOOTER. Razor scooters have been built to certain Razor design specifications. The original equipment supplied at the time of sale was selected on the basis of its compatibility with the frame, fork and all other parts. Certain aftermarket products may or may not be compatible. Use of any non-Razor parts will void your warranty.

Need Help? Visit our web site for updates and a list of authorized service centers at www.razor.com or call toll-free at 866-467-2967 Monday - Friday 8:00 AM - 5:00 PM Pacific Time.

SET UP AND USAGE INSTRUCTIONS

Installing the Handlebars

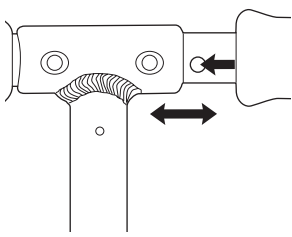

1 Insert and secure the left and right handlebars by pressing the spring-loaded buttons and inserting them into the T-bar.

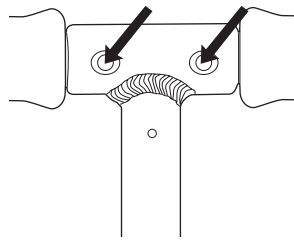

2 Make certain the spring-loaded button engages the hole in the T-bar for each handlebar.

Folding/Unfolding the Scooter

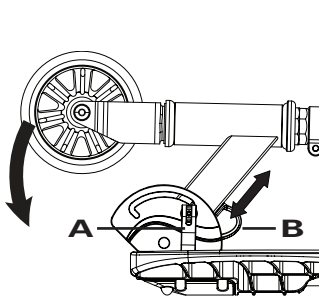

1 To release the folding mechanism, hold the T-bar with one hand between the collar clamp and the quick-release lever and place one foot on the deck plate. Pull lever (A) on folding mechanism outward. Then pull up on the red release lever (B) and pull handlebars upward until steering tube is locked into place. Move folding mechanism lever inward to lock in place.

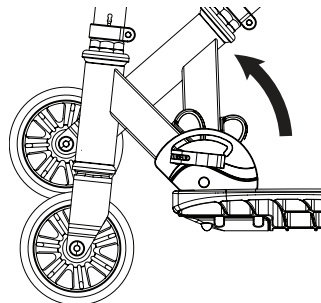

2 The joint lever is spring-loaded and will automatically lock in the upright position when fully upright.

Note: If tension on folding mechanism lever (A) is too tight/too loose, carefully twist the black knob located on the opposite side of the lever (A) to tighten/loosen the tension so you can secure the steering tube in place.

Adjusting the Handlebar Height

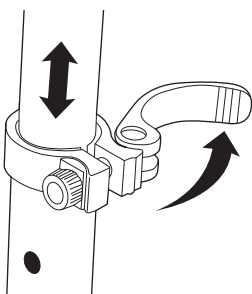

1 To adjust the height of the handlebars, unlock the extension tube by pulling outward on the quick-release lever and pushing the button located on the extension tube. Slide the T-bar to the desired height and secure by pushing inward on the quick release lever.

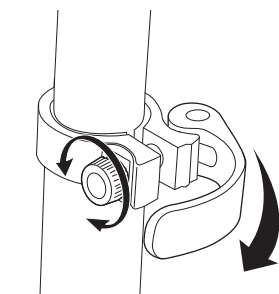

2 The tension of the quick-release lever can be adjusted by tightening or loosening the allen bolt. Be careful not to over-tighten. You should be able to open and close the quick-release lever by hand.

! WARNING: Failure to properly engage the spring-loaded buttons may cause the handlebars to dislodge while riding and may cause you to lose control and fall. When correctly engaged the handlebars will not rotate nor will they move sideways. Note that when properly engaged, the spring-loaded buttons are clearly visible in the holes on the T-bar.

! WARNING: Keep your fingers clear of the pivoting mechanism when folding or unfolding the scooter. Make sure others are standing clear.

! WARNING: Failure to properly secure the quick-release lever may cause the T-bar to slide up or down while riding which may cause you to lose control and fall. With the quick-release properly adjusted and secured, the handlebars will not move up or down.

CHECK BEFORE RIDING

□ Collar Clamp

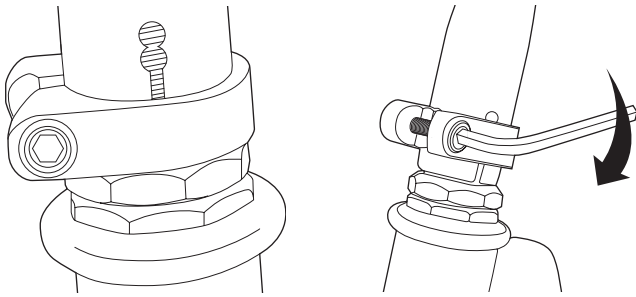

Using the 5mm Allen wrench, check that the collar clamp bolt is tightened securely.

Note: If the handlebars are not properly aligned with the front wheel, loosen the bolt on the collar clamp and position the front wheel until it is perpendicular with the steering tube; re-tighten bolt on collar clamp to lock in place.

□ Wheels and Bearings

Under normal circumstances and conditions, Razor wheels and wheel bearings are maintenance free. Nonetheless, it is the responsibility of the owner or guardian to periodically inspect the wheels for wear and tear, the axle for proper tightness, and bearings for side-to-side play and loose parts. When a wheel or wheel bearing develops play, this is an indication of excess wear and replacement is necessary. Replace immediately with only genuine Razor wheels. Worn wheels and bearings are considered normal wear-and-tear and are not covered by the Razor Warranty. Wheels other than genuine Razor wheels may not be compatible with your Razor caster scooter. The use of anything other than genuine Razor replacement parts may affect your safety and will void your warranty.

□ Cleaning Your Caster Scooter

Wipe with a damp cloth to remove dirt and dust. Do not use industrial cleaners or solvents as they may damage the surfaces. Do not use alcohol, alcohol-based or ammonia-based cleaners as they may damage or dissolve the plastic components or soften the decals or decal adhesive.

□ How to Ride

With your hands on the grips and holding the scooter upright, place one foot on the scooter deck, leaving your other foot on the ground for stability. Roll the scooter back and forth a bit to make sure you are comfortable and secure on it before taking off. When you are ready to go, simply use your ground foot to push off and begin rolling. Once rolling, the Siege™ Caster Scooter's unique design will allow you to gain speed without having to step down and drift around corners as though on ice! To gain speed without stepping down, simply sway the back end of the scooter back and forth. This fishtail motion will begin to propel the scooter forward, eliminating the need to step down and pedal. In order to drift around corners, all you have to do is lean the rear deck plate into the turn. The degree of drift is completely up to you and is controlled by a combination of how fast you're going and how hard you lean into the drift.

⚠ WARNING: Wheelies and other stunt-type riding reduces your ability to maneuver and control your caster scooter. Take the necessary precautions, such as wearing appropriate protective gear and practice in a area free from obstructions.

CASTER SCOOTER PARTS LIST

Keep your caster scooter running for years with genuine Razor parts. Visit our web site or e-mail us for more information on spare part availability. (Specifications subject to change without notice.)

- | | |
|-----------------------------------|-----------------------|
| 1. Grips | 9. Axle Bolts |
| 2. Handlebars | 10. 125mm Front Wheel |
| 3. T-Bar | 11. Supporting Tube |
| 4. Quick Release Lever | 12. 64mm Rear Wheel |
| 5. Extension/Steering Tube | 13. Caster |
| 6. Collar Clamp | 14. Deck |
| 7. Headset Bearings (upper/lower) | 15. Folding Mechanism |
| 8. Front Fork | |

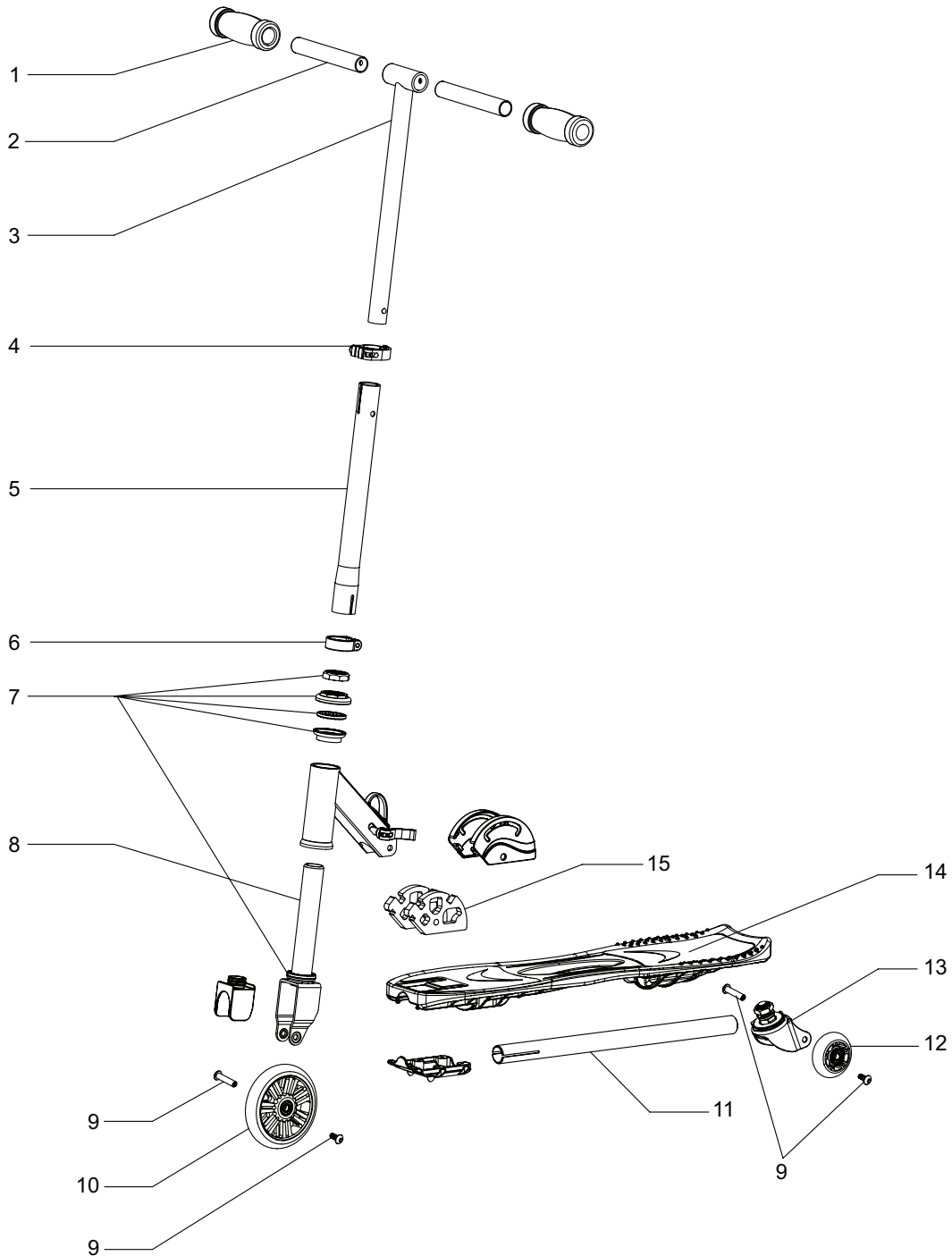

SAFETY REMINDERS

PRE-RIDE CHECKLIST



Loose Parts

Check and secure all fasteners before every ride. Make sure the steering tube clamps, steering tube extension quick release, and handlebars spring buttons are locked properly in place before riding.



Replacement Parts

For a complete selection of parts, visit our website at www.razor.com.



Safety Gear

Always wear proper protective equipment such as an approved safety helmet. Elbow pads and kneepads are recommended. Always wear shoes (lace-up shoes with rubber soles), never ride barefooted or in sandals, and keep shoelaces tied and out of the way of the wheels.



Be Careful!

You will see people on TV and maybe even people you know doing tricks and stunts. These are people who have been practicing on scooters for a very long time. Don't try something until you are ready. Avoid steep inclines and don't ride too fast — you can lose control and fall. Skateboard parks are not designed for scooters. Never ride in traffic or on the street and watch your surroundings for pedestrians, bikers, boarders, scooter riders and skaters.

Maintain a hold on the handlebars at all times.



DO NOT RETURN TO STORE
Failure to follow these instructions may damage
your caster scooter and void your warranty.

WARRANTY

Razor Limited Warranty

The manufacturer warrants this product to be free of manufacturing defects for a period of 6 months from date of purchase. This Limited Warranty does not cover normal wear and tear of wheels and bearings or any damage, failure or loss caused by improper maintenance or storage.

This Limited Warranty will be void if the product is ever

- used in a manner other than for recreation
- modified in any way
- rented

The manufacturer is not liable for incidental or consequential loss or damage due directly or indirectly to the use of this product.

Razor does not offer an extended warranty. If you have purchased an extended warranty, it must be honored by the store at which it was purchased.

For your records, save your original sales receipt with this manual and write the serial number below.

Item Number:

13055899

Need Help? Visit our web site for updates and a list of authorized service centers at www.razor.com or call toll-free at 866-467-2967 Monday - Friday 8:00 AM - 5:00 PM Pacific Time.

Printed in China for:
Razor USA LLC
P.O. Box 3610
Cerritos, CA 90703

Copyright © 2003-2010 Razor USA, LLC. All rights reserved. RAZOR and the Razor Logo Design are among the registered trademarks of Razor USA LLC in the United States and/or select foreign countries. Siege™ is a trademark of Razor USA.