



## POCKET MOD™ BELLEZZA



# OWNER'S MANUAL

**Read and understand this entire manual before allowing child to use this product! For assistance contact Razor.  
DO NOT RETURN TO STORE.**

**NOTE: Manual illustrations are for demonstration purposes only.  
Illustrations may not reflect exact appearance of actual product.  
Specifications subject to change without notice.**

**Please have your product along with the 19 character product I.D. code with you  
before contacting Razor for warranty assistance and/or replacement parts.**

**Product I.D. Code: \_\_\_\_\_ - \_\_\_\_\_ - \_\_\_\_\_**

# CONTENTS

Safety Warnings .....	1-2	Repair and Maintenance.....	8-11
Before You Begin.....	3	Troubleshooting Guide .....	12
Assembly and Set-Up.....	4-6	Pocket Mod Bellezza Parts.....	13
Charging Battery/Pre-ride Checklist .....	7	Warranty .....	15
Usage .....	8		

# SAFETY WARNINGS

**⚠ WARNING:** This is the “older rider” version of the popular Pocket Mod. It is bigger and faster than the original and it is not intended for riders under 14. Younger riders should not use the Pocket Mod Bellezza, they should ride the original Pocket Mod for ages 13 and up.

**⚠ WARNING:** Riding a Pocket Mod Bellezza does present potential risks and caution is required. Like any riding product, the Pocket Mod Bellezza has inherent hazards associated with its use (for example, falling off or riding it into a hazardous situation). Like any riding product, the Pocket Mod Bellezza can and is intended to move and it is therefore, of course, possible to lose control or otherwise get into dangerous situations. Both children and adults responsible for supervising them must recognize that if such things occur, a rider can be seriously injured or die, even when using safety equipment and other precautions. **RIDE AT YOUR OWN RISK AND USE COMMON SENSE.**

**⚠ WARNING: NOT FOR CHILDREN UNDER AGE 14 OR HEAVIER THAN 220 LB (100 KG).** Because products, like the Pocket Mod Bellezza, can and do present potential hazards plainly associated with their use, it is well recognized THE NEED FOR EXERCISE OF PARENTAL RESPONSIBILITY IN SELECTING RIDING PRODUCTS APPROPRIATE TO THE AGE OF A CHILD, OR PARENTAL SUPERVISION IN SITUATIONS IN WHICH CHILDREN OF VARIOUS AGES MAY HAVE ACCESS TO THE SAME RIDING PRODUCTS, IS IMPORTANT. Not every product is appropriate for every age or size of child, and different age recommendations are found within this category of product which are intended to reflect the nature of the hazards and the expected mental or physical ability, or both, of a child to cope with the hazards.

Razor recommends that children under the age of 14 not be permitted to use this product. This recommendation is based not just on age or weight or height – it reflects consideration of expected maturity and skills as well as physical size. The recommended rider age of 14 years or older is only an estimate and can be affected by the rider’s size, weight, or skills – not every rider 14 years old will be suited to the product. Certainly, any rider unable to fit comfortably on the Pocket Mod Bellezza should not attempt to ride it, but a **parent’s decision to allow his or her child to ride this product should be based on the child’s maturity, skill, and ability to follow rules. Razor emphasizes that adults are strongly advised not to disregard Razor’s recommendations or permit younger children to ride the Pocket Mod Bellezza.**

**Keep this product away from small children and remember that it is intended for use only by persons who are, at a minimum, completely comfortable and competent while operating the Pocket Mod Bellezza.**

Persons with any mental or physical conditions that may make them susceptible to injury, impair their physical dexterity or mental capabilities to recognize, understand, and follow safety instructions and to be able to understand the hazards inherent in Pocket Mod Bellezza use, should not use or be permitted to use products inappropriate for their abilities. Persons with heart conditions, head, back or neck ailments (or prior surgeries to these areas of the body), or pregnant women, should be cautioned not to operate such products.

**NOTICE:** This manual contains many warnings and cautions concerning the consequences of failing to maintain, inspect or properly use your electric ride-on product. Because any incident can result in serious injury or even death, we do not repeat the warning of possible serious injury or death each time such a possibility is mentioned.

**DO NOT EXCEED THE WEIGHT LIMIT OF 220 lb (100 kg). Rider weight does not necessarily mean a person’s size is appropriate to fit or maintain control of the Pocket Mod Bellezza.**

## CHECK AND MAINTAIN PRODUCT CONDITIONS

Before use, check to confirm that any and all chain guards or other covers and guards are in place and in serviceable condition. Check that the brakes are functioning properly, and that tires are inflated properly and have sufficient tread remaining. The Pocket Mod Bellezza should be maintained and repaired in accordance with the manufacturer’s specifications, using only the manufacturer’s authorized replacement parts, and should not be modified from the manufacturer’s original design and configuration. Replace worn or broken parts immediately.

## ACCEPTABLE RIDING PRACTICES AND CONDITIONS

**Always check and obey any local laws or regulations, which may affect the locations where the Pocket Mod Bellezza may be used. Keep safely away from cars and motor vehicle traffic at all times, and only use where allowed and with caution.**

Do not activate the speed control on the hand grip unless you are on the Pocket Mod Bellezza and in a safe, outdoor environment suitable for riding.

The normal powered top speed of the Pocket Mod Bellezza will be approximately 16 mph (26 km/h), which can be affected by conditions, such as rider weight, inclines, tire inflation and battery charge level. Avoid excessive speeds that can be associated with downhill rides.

Maintain a hold on the handlebars at all times. Do not touch the brakes or motor on your Pocket Mod Bellezza when in use or immediately after riding as these parts can become very hot.

Ride defensively. Watch out for potential obstacles that could catch your wheel or force you to swerve suddenly or lose control. Be careful to avoid pedestrians, skaters, skateboards, scooters, bikes, children or animals who may enter your path, and respect the rights and property of others.

The Pocket Mod Bellezza is intended for use on flat, dry surfaces, such as pavement or level ground, without loose debris, such as sand, leaves, rocks or gravel. Wet, slick, bumpy, uneven or rough surfaces may impair traction and contribute to possible accidents. Do not ride your Pocket Mod Bellezza in mud, ice, puddles or water. Watch out for potential obstacles that could catch your wheel or force you to swerve suddenly or lose control. Avoid sharp bumps, drainage grates, and sudden surface changes.

Do not attempt or do stunts or tricks on the Pocket Mod Bellezza. The Pocket Mod Bellezza is not made to withstand abuse from misuse, such as jumping, curb grinding or any other type of stunts. Racing, stunt riding, or other maneuvers also enhance risk of loss of control, or may cause uncontrolled rider actions or reactions.

Never allow more than one person at a time to ride the Pocket Mod Bellezza.

Do not ride at night or when visibility is limited.

## SAFETY WARNINGS

Never use near steps or swimming pools.

Do not allow hands, feet, hair, body parts, clothing, or similar articles to come in contact with moving parts, wheels, or drivetrain, chain while the motor is running.

Never use headphones, a cell phone or text when riding.

Never hitch a ride with a vehicle.

Do not ride your Pocket Mod Bellezza in wet or icy weather and never immerse the Pocket Mod Bellezza in water, as the electrical and drive components could be damaged by water or create other possibly unsafe conditions. Never risk damaging surfaces, such as carpet or flooring, by use of the Pocket Mod Bellezza indoors.

### PROPER RIDING ATTIRE

Always wear proper protective equipment, such as an approved safety helmet (with chin strap securely buckled), elbow pads and kneepads. A helmet may be legally required by local law or regulation in your area. A long-sleeved shirt, long pants, and gloves are recommended. Always wear athletic shoes (lace-up shoes with rubber soles) and keep shoelaces tied and out of the way of the wheels, motor and drive system. Never ride barefooted or in sandals.

### USING THE CHARGER

The charger supplied with the Pocket Mod Bellezza should be regularly examined for damage to the cord, plug, enclosure and other parts. In the event of such damage, the Pocket Mod Bellezza must not be charged until the charger has been repaired or replaced.

Use only with the recommended charger.

Use caution when charging.

The charger is not a toy. Charger should be operated by an adult.

Do not operate charger near flammable materials.

Unplug charger and disconnect from Pocket Mod Bellezza when not in use.

Always disconnect from the charger prior to wiping down and cleaning your Pocket Mod Bellezza with damp cloth.

**FAILURE TO USE COMMON SENSE AND HEED THE WARNINGS INCREASES RISK OF SERIOUS INJURY. USE WITH APPROPRIATE CAUTION AND SERIOUS ATTENTION TO SAFE OPERATION.**

## BEFORE YOU BEGIN

Remove contents from box. Remove the separators that protect the components from damage during shipping. Inspect the contents of the box for scratches in the paint, dents or kinked cables that may have occurred during shipping. Because the Pocket Mod Bellezza is 95 percent assembled and packed at the factory, there should not be any problems, even if the box has a few scars or dents.

### Estimated Assembly and Set-Up Time

Razor recommends assembly by an adult.

Allow up to 15 minutes for assembly.

Allow up to 12 hours for initial charge (see page 7 for charging information).

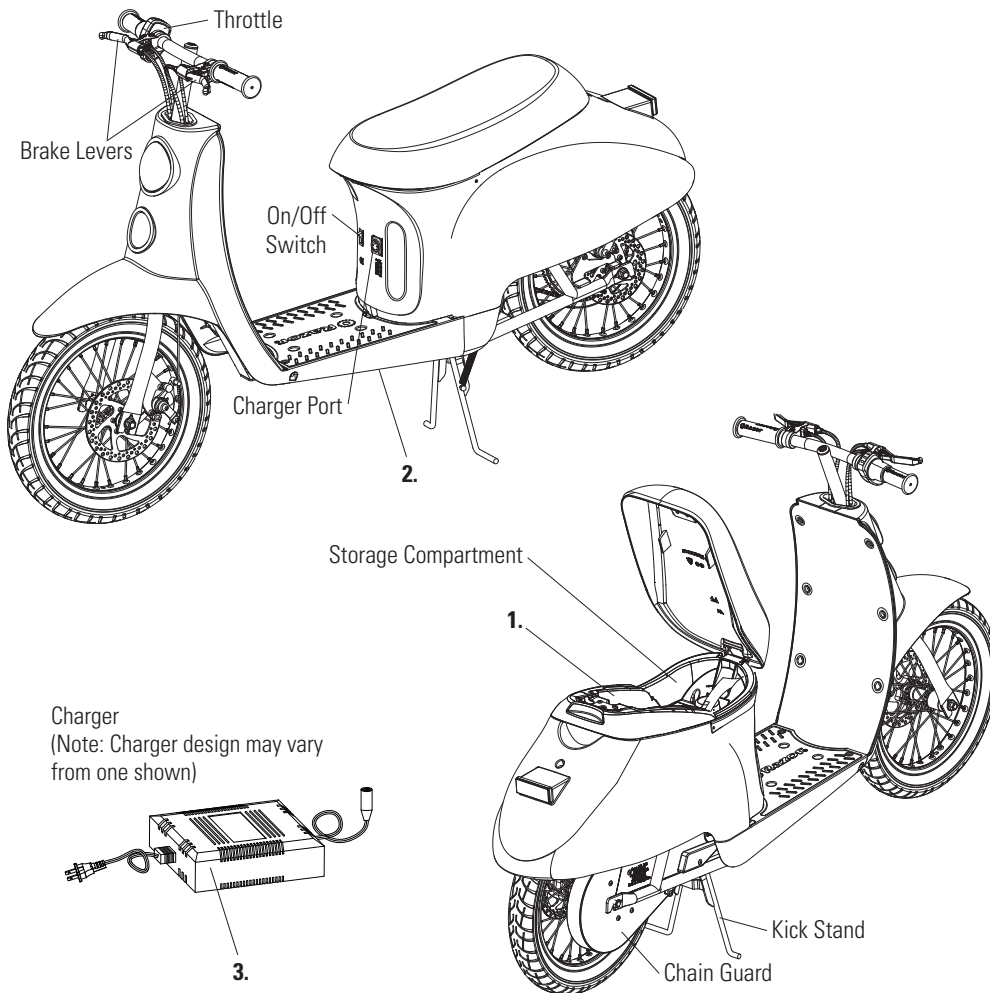

### Required Tools

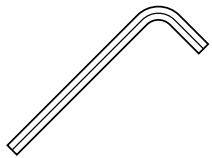

5 mm and 6 mm  
Allen Wrenches



Two (2) 13 mm/15 mm  
Wrenches

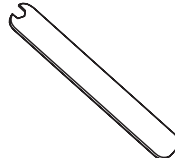

Spoke Tightener

### ⚠ WARNING:

DO NOT USE NON-RAZOR PRODUCTS WITH YOUR RAZOR POCKET MOD BELLEZZA.

The Pocket Mod Bellezza has been built to certain Razor design specifications. The original equipment supplied at the time of sale was selected on the basis of its compatibility with the frame, fork and all other parts. Certain aftermarket products may not be compatible and will void your warranty.

### Product I.D. Code:

1. Inside Storage Compartment
2. Underneath Frame
3. Charger
4. UPC Side of Box (not shown)

### Plastic Bag Contents:

- Charger
- Tools
- Owner's Manual

**Need Help?** Visit our web site for replacement parts, product support, a list of authorized service centers in the US and customer service contact information at [www.razor.com](http://www.razor.com). Please have the product I.D. code (located on the white label of your product) available for better assistance. Additional Customer Service contact information is listed at the back of this manual.

# ASSEMBLY AND SET-UP

Turn power switch OFF before conducting any maintenance procedures.

## Attaching the Handlebars

Tool Required: 6 mm Allen wrench.

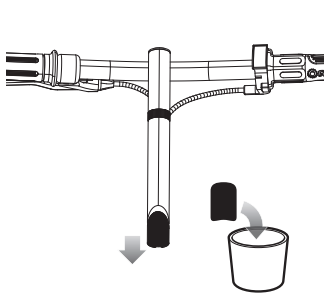

**1** Remove plastic protector at the end of the steering tube.

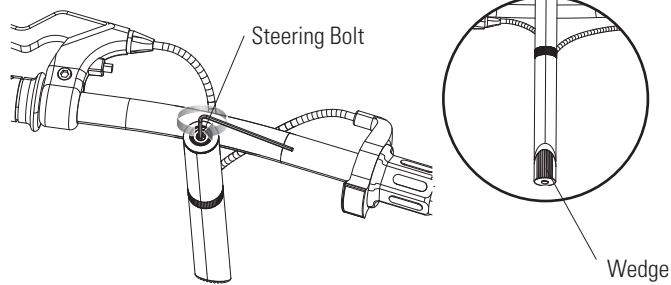

**2** Using a 6 mm Allen wrench, loosen steering bolt in four (4) complete turns so that the wedge is loose and not touching steering tube.

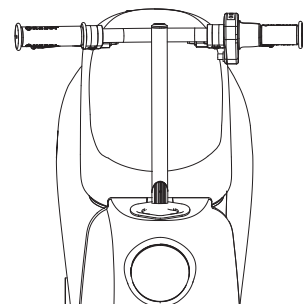

**3** Facing the front of the Pocket Mod Bellezza, position the handlebars so the throttle is on your right (the red "SAFETY ZONE" print will be facing you). Align wedge inside handlebar tube.

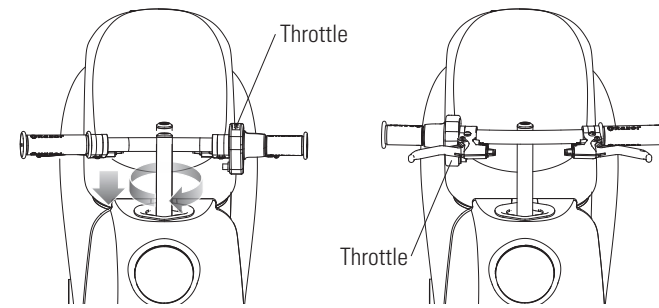

**4** While inserting the steering tube down into the handlebar tube, hold steering bolt steady with thumb and rotate handlebars 180 degrees to the left.

**Note:** The throttle should now be on your left.

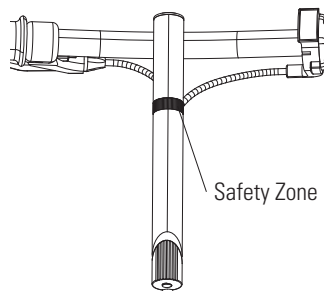

**5** Slowly slide the handlebars up to make certain that the bar is in the "SAFETY ZONE". Failure to secure the handlebars within the safety zone can cause the handlebars to come out while riding.

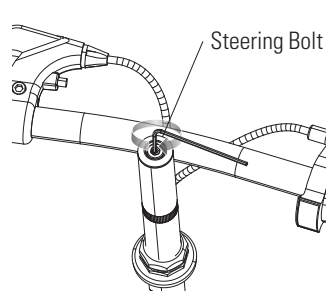

**6** Securely tighten bolt using 6 mm Allen wrench.

**Note:** Make sure the brake cables/wires are out of the way before inserting the handlebar into the fork.

**WARNING:** Periodically check to make sure the steering bolt is tightly fastened.

**Note:** Failure to secure the handlebars within the safety zone can cause the handlebars to come out while riding.



## ASSEMBLY AND SET-UP

### □ Positioning the Brake Levers

**Tool Required:** 5 mm Allen Wrench.

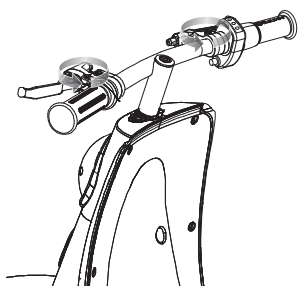

**1** Loosen the 5 mm bolt located on the brake levers to adjust the angle of the brake levers to a comfortable position for the rider.

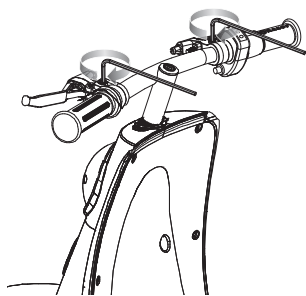

**2** When desired position is reached, re-tighten bolt until brake levers are securely in place.

### □ Attaching the Front Wheel

**Tools Required:** Two (2) 15 mm Wrenches.

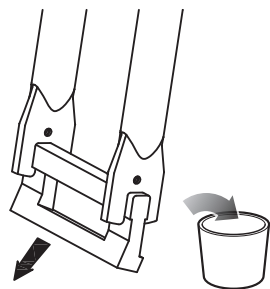

**1** Remove the plastic packing material from the front fork.

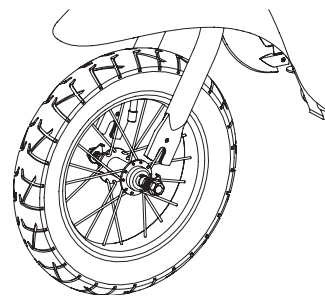

**2** Insert the wheel into the front fork with the lock washers on the outside of the fork.

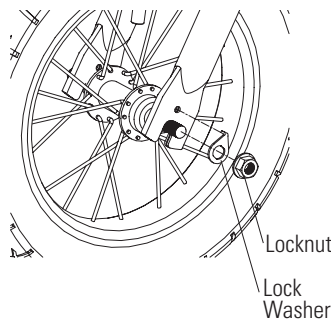

**3** Insert the tab on the lock washer into the hole on the front fork and tighten the 15 mm locknuts on both sides of the wheel.

**Need Help?** Visit our web site for replacement parts, product support, a list of authorized service centers in the US and customer service contact information at [www.razor.com](http://www.razor.com). Please have the product I.D. code (located on the white label of your product) available for better assistance. Additional Customer Service contact information is listed at the back of this manual.

# ASSEMBLY AND SET-UP

## □ Checking Spoke Tension

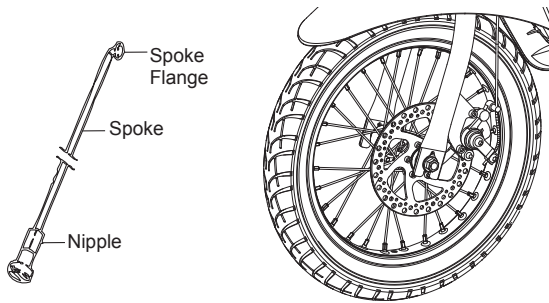

**1** Verify spoke tension by grasping and shaking each spoke. Spoke should not be loose from hub. Look for any play between spoke flanges where it mates with hub. Try to turn nipple using your fingers. You should not be able to spin any nipple by hand. If one or more spokes are loose, or if you can turn any nipple using your fingers, all spokes must be checked and need to be tightened with a spoke tightener.

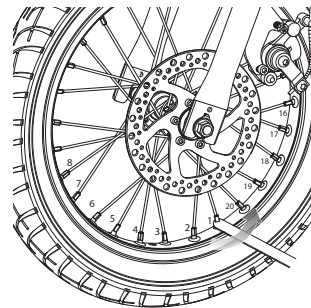

**2** Start with spoke closest to tire valve and tighten each nipple. In sequence, exactly 1/4 to 1/2 turn. A single 1/4 to 1/2 turn may not be enough to bring the spokes into proper tension. Continue tightening all spokes in sequence, no more than 1/2 turn until all spokes are tight.

## □ Inflating the Tires

Tires are inflated when shipped, but they invariably lose some pressure between the point of manufacturing and your purchase. **Inflate the tires to the correct PSI before first time use.**

Lower air pressure can result in a shorter ride time. Periodically check both tires. Reinflate when needed.

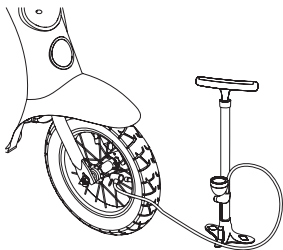

Using a bicycle tire pump equipped for a Schrader valve, inflate the tires to the PSI indicated on the sidewall of the tires.

**⚠ WARNING:** Regularly check the spoke tension and retighten the spokes whenever loose. If you have any doubt, ask an experienced motorcycle or bicycle mechanic to inspect your spokes to determine if the spokes need tightening or adjusting.

**Note:** Tightening each nipple more than a 1/2 turn each can cause the wheel to become distorted and wobbly, thus permanently damaging the wheel.

**Note:** The pressurized air supplies found at gasoline stations are designed to inflate high-volume automobile tires. If you decide to use such an air supply to inflate your Pocket Mod Bellezza tires, first make sure the pressure gauge is working, then use very short bursts to inflate to the correct PSI. If you inadvertently over-inflate the tires, release the excess pressure immediately.

## CHARGING THE BATTERY

Your Pocket Mod Bellezza may not have a fully charged battery; therefore it is a good idea to charge the battery prior to use.

- Initial charge time: 12 hours.
- Recharge time: up to 12 hours, even if the light turns green. Recommended maximum charging time is 24 hours.
- Always charge the battery immediately after riding.
- Fully charge battery before storing for extended periods of time.
- Unplug charger from the wall outlet when not in use.
- Failure to recharge battery periodically may result in a battery that will not accept a charge.
- Make sure power switch is turned **OFF** when unit is not in use. If the power switch is left on for an extended period of time, the battery may reach a stage at which it will no longer hold a charge.
- To ensure long battery life, never store the product in freezing or below freezing temperatures! Freezing will permanently damage the battery.
- Run time: Up to 70 minutes of continuous ride time. Run time may vary depending on riding conditions, rider weight, climate and/or proper maintenance.
- Constant stopping and starting may shorten ride time.
- Battery life can vary depending on proper maintenance and usage of the unit.

Charger

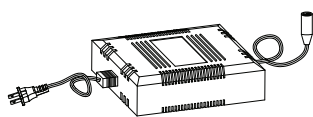

**Note:** Make sure power is turned **OFF** when unit is not in use. If the power switch is left on for an extended period of time, the battery may reach a stage at which it will no longer hold a charge.

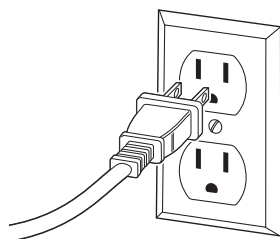

**1** Plug the charger plug into wall outlet. The light on the charger should be green.

**Note:** If green light (LED) does not turn on, try a different outlet.

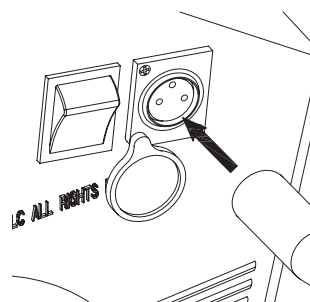

**2** Make sure the power switch is in the **OFF** position. Plug the charger into the charger port on the product. The light on the charger should turn red during charging. The light will turn green when charging is complete.

**⚠ WARNING:** Use **ONLY** with the recommended charger. Batteries are only to be charged under adult supervision. The charger is not a toy. Always disconnect the charger before wiping down and/or cleaning the Pocket Mod Bellezza with a damp cloth.

The charger supplied with the Pocket Mod Bellezza should be regularly examined for damage to the cord, plug, enclosure and other parts. In the event of such damage, the Pocket Mod Bellezza must not be charged until it has been repaired or replaced.

Chargers have built-in overcharge protection to prevent battery from being overcharged.

**Note:** If the charger gets warm during regular use, this is a normal response and is no cause for concern. If your charger does not get warm during use, it does not mean that it is not working properly.

Wall outlet - Green (stand by)  
Wall outlet and unit - Red (charging)  
Wall outlet and unit - Green (charged)

**Note:** Continue charging unit even if light turns green prior to 12 hours.

**⚠ WARNING:** Battery charge can deplete over time. Periodically recharge battery when not in use.

## PRE-RIDE CHECK LIST



### Brakes

Check the brakes for proper function. When you squeeze the levers, the brakes should provide positive braking action. When you apply the brakes with the speed control on, the brakes cut-off switch will stop the motor.



### Tires

Periodically inspect the tires for excess wear, and regularly check the tire pressure and inflate as necessary. If you get a flat tire, the inner tube can be patched or a new tube can be purchased from Razor or an authorized service center.



### Frame, Fork and Handlebars

Check for cracks or broken connections. Although broken frames are rare, it is possible for an aggressive rider to run into a curb or object and wreck, bend or break a frame. Get in the habit of inspecting your product on a regular basis.



### Hardware/Loose Parts

Before every ride, check all parts, such as nuts, bolts, cables, fasteners, etc., to ensure they are secure and assembled correctly. There should not be any unusual rattles or sounds from loose parts or broken components. If the unit is damaged, do not ride. **Reference "Safety Warnings" on pages 1 and 2 of this manual.**



### Safety Gear

Always wear proper protective gear, such as an approved safety helmet. Elbow pads and kneepads are recommended. Always wear athletic shoes (lace-up shoes with rubber soles) and keep shoelaces tied and out of the way of the wheels, motor and drive system. **NEVER RIDE BAREFOOTED OR IN SANDALS.**



### Laws and Regulations

Always check and obey any local laws or regulations.



### Insurance

Do not assume that your existing insurance policies necessarily provide coverage for electric product use. Check with your insurance company for information regarding insurance.



## USAGE

### Starting the Pocket Mod Bellezza

Place both hands on the handlebars. Slowly push forward with one foot and apply the throttle.

**Note:** Keep both feet on the base and both hands on the handlebars when product is in motion.

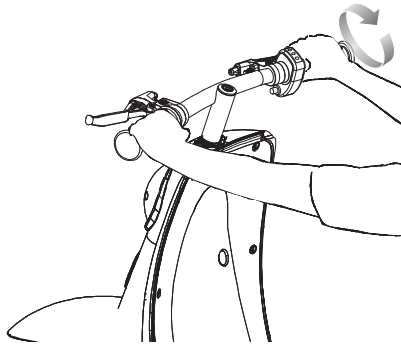

### Stopping the Pocket Mod Bellezza

Release the throttle and apply the brakes.

**Note:** When coming to a complete stop, place both feet on the ground to balance the unit.

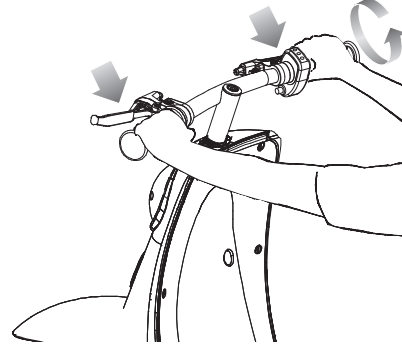

## REPAIR AND MAINTENANCE

Turn power switch "OFF" before beginning repair or maintenance:

- Read the instructions
- Remove charger plug
- Turn the power switch off
- Secure the unit under repair
- Exercise caution around exposed parts
- Contact Razor customer service if unsure about any repair or maintenance

### Adjusting the Brakes

Tools required: 5 mm Allen wrench

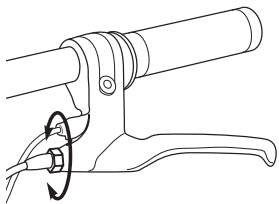

**1** To adjust brake cable play, thread the brake lever adjuster in or out 1/4 to 1/2 turn until the desired brake adjustment is attained. Most adjustments are complete at this step. If brakes still needs further adjustment, proceed to step 2.

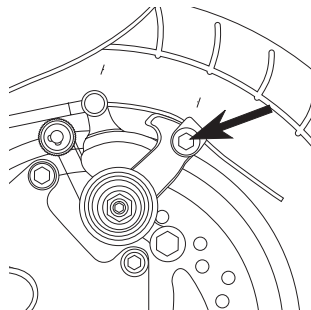

**2** If the brake has too much slack, loosen the rear anchor bolt with a 5 mm Allen wrench and pull the brake wire tighter. The distance of the brake wire between the end of the cable and the anchor bolt should be between 37 mm and 44 mm.

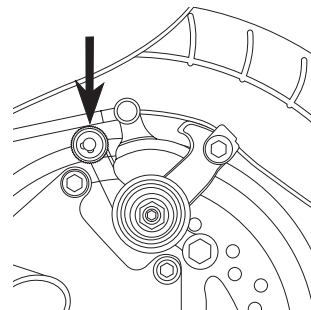

**3** If the disc brake is dragging on the brake pads, use your fingers to twist the caliper adjuster in either direction until disc is centered between pads.

**WARNING:** The brakes are capable of causing the electric motor bike to skid the tire throwing an unsuspecting rider. Practice in an open area free from obstacles until you are familiar with the brake function. Avoid skidding to a stop as this can cause you to lose control or damage the tires.

**Testing the Brakes.** To use the brakes, squeeze the levers to increase the pressure on the brakes. The brake levers are fitted with a cable adjuster to compensate for cable stretch and/or to fine-tune the lever movement to brake engagement. If brakes are not engaging properly, follow instructions for adjusting the brakes.

**Need Help?** Visit our web site for replacement parts, product support, a list of authorized service centers in the US and customer service contact information at [www.razor.com](http://www.razor.com). Please have the product I.D. code (located on the white label of your product) available for better assistance. Additional Customer Service contact information is listed at the back of this manual.

# REPAIR AND MAINTENANCE

## Chain and Rear Wheel Replacement

**Tools Required:** Phillips Screwdriver, (2) 15 mm Wrenches.

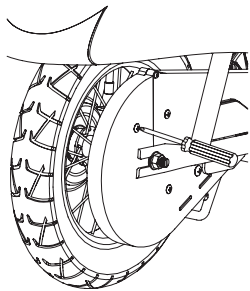

**1** Loosen the five (5) Phillips screws on the chain guard. Remove chain guard.

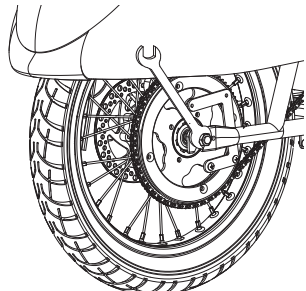

**2** Using two (2) 15 mm wrenches, loosen the locknuts. Slide the wheel forward to loosen the chain and remove the wheel.  
**Note:** Hardware sequence on the right.

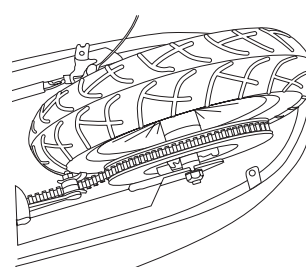

**3** Install the new chain or wheel by slipping the chain around the axle. Slide the wheel forward and maneuver the chain onto the rear sprocket, motor sprocket and chain tensioner.

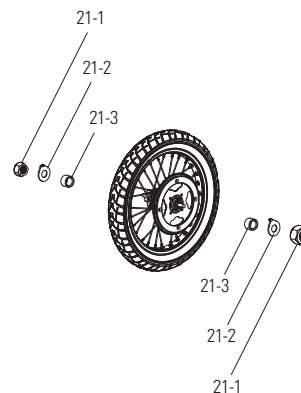

\*Note: The arrangement of the hardware sequence:

**Left Side (Brake)**  
21-1 15 mm Locknut  
21-2 Lock Washer

**Frame**  
21-3 Spacer

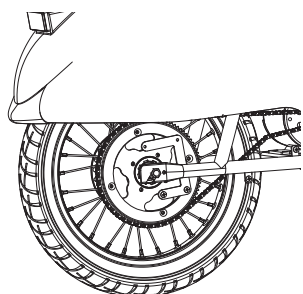

**4** Verify chain is properly installed on each sprocket and chain tensioner is correctly positioned at the bottom of the chain.

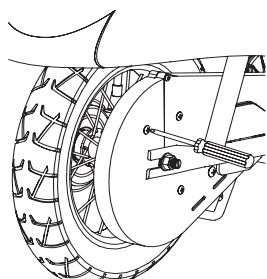

**5** Reattach the chain guard.

**Right Side (Throttle)**  
21-1 15 mm Locknut  
21-2 Lock Washer

**Frame**  
21-3 Spacer

# REPAIR AND MAINTENANCE

## □ Front Wheel Replacement

**Tools Required:** (2) 15 mm Wrenches

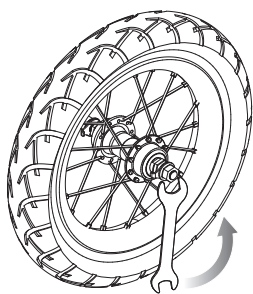

**1** Using two (2) 15 mm wrenches, remove the locknuts and lock washers on both sides of the front wheel, then remove front wheel.

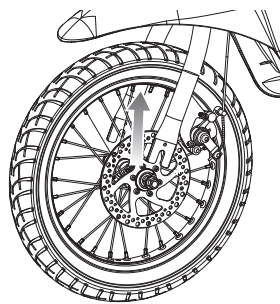

**2** Insert replacement wheel into the front fork.

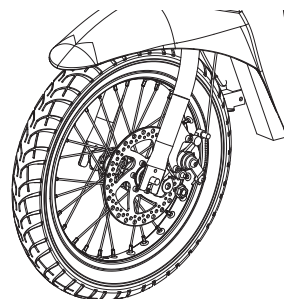

**3** Re-insert the tab on the lock washers into the holes on the front fork and tighten the locknuts on both sides of the wheel.

## □ Replacing the Fuse

**Tools Required:** Phillips Screwdriver

**Turn power switch OFF.**

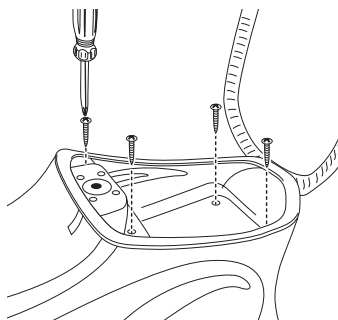

**1** Open up seat and loosen the four (4) Phillips screws located inside the storage compartment and remove tray.

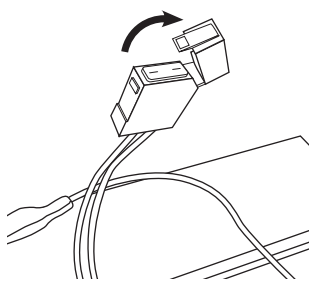

**2** Locate fuse box on top of batteries. Open the fuse cover to expose the fuse.

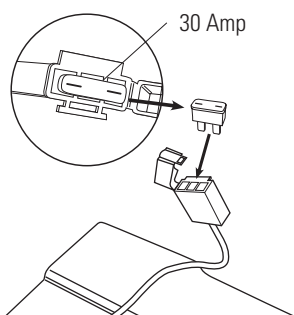

**3** Remove the fuse and replace with a new one of equal amperage. Close fuse box. Reattach storage compartment.

### **⚠ WARNING:**

To prevent shock, please follow the instructions accordingly and do not skip or combine any steps.

**Need Help?** Visit our web site for replacement parts, product support, a list of authorized service centers in the US and customer service contact information at [www.razor.com](http://www.razor.com). Please have the product I.D. code (located on the white label of your product) available for better assistance. Additional Customer Service contact information is listed at the back of this manual.

## REPAIR AND MAINTENANCE

### ❑ Battery Care and Disposal

Do not store in freezing or below freezing temperatures! To properly maintain your battery and ensure maximum battery life, carefully read the "Charging the Battery" section on page 7 of this owner's manual.



CONTAINS SEALED LEAD ACID BATTERIES. BATTERIES MUST BE RECYCLED.

**Disposal:** Your Razor product uses sealed lead-acid batteries which must be recycled or disposed of in an environmentally safe manner. Do not dispose of a lead-acid battery in a fire. The battery may explode or leak. Do not dispose of a lead-acid battery in your regular household trash. The incineration, land filling or mixing of sealed lead-acid batteries with household trash is prohibited by law in most areas. Return exhausted batteries to a federal or state approved lead-acid battery recycler or a local seller of automotive batteries. If you live in Florida or Minnesota, it is prohibited by law to throw away lead-acid batteries in the municipal waste stream.

### ❑ Charger

The charger supplied with the electric product should be regularly examined for damage to the cord, plug, enclosure and other parts and in the event of such damage, the product must not be charged until it has been repaired or replaced.

Use ONLY with the recommended charger.

### ❑ Wheels

Wheels and drive system are subject to normal wear and tear. It is the responsibility of the user to periodically inspect wheels for excess wear, and adjust and replace drive train components as required.

### ❑ Replacement Parts

The most frequently requested replacement parts are available for purchase at some Razor retail partners. For the complete selection of replacement parts visit [shop.razor.com](http://shop.razor.com).

### ❑ Repair Centers

For a list of authorized Razor repair centers:

- Check online at [www.razor.com](http://www.razor.com).
- Additional Customer Service contact information is listed on the back of this manual.

**⚠ WARNING:** If a battery leak develops, avoid contact with the leaking acid and place the damaged battery in a plastic bag. Refer to the disposal instructions at left. If acid comes into contact with skin or eyes, flush with cool water for at least 15 minutes and contact a physician.

**⚠ WARNING:** Battery posts, terminals and related accessories contain lead and lead compounds. **Wash your hands after handling.**

# TROUBLESHOOTING GUIDE

\*Unit(s) should be turned off and fully charged prior to doing any Troubleshooting

**NOTE:** All troubleshooting steps should be performed by an adult only

Problem	Possible Cause	Solution
Does Not Work Out Of The Box	Loose connection(s)	Check for loose connections/wires
No Longer Works	Blown Fuse	Replace if needed
	Loose connection(s)	Check for loose connections/wires
	Charger not working	Check power to wall outlet and/or try a different outlet  Check lights on charger: Plugged into wall = Green Plugged into wall & unit (Charging) = Red Charging Complete = Green No lights - Replace Charger
	Battery will not hold a charge	With no weight on the unit, lift up back end and apply the throttle. If motor engages - Replace Battery  If motor does not engage, but makes a clicking sound - Replace Battery If motor does not engage, no clicking sound - Replace Control Module
Short Ride Time/Runs Slow	Rider's weight	Do not exceed <b>220 lb</b> maximum weight limit
	Low tire pressure	Check tires for correct PSI.
	Riding conditions	Use only on flat, dry surfaces. Avoid inclines and areas with heavy debris
	Battery not fully charged	Charge unit for a full 12 hrs
	Old/damaged Battery	With no weight on the unit, lift up back end and apply the throttle. If motor engages - Replace Battery
	Improper battery maintenance	Charge battery at least once a month when not in use  Do not store unit in freezing or below freezing temperatures. Freezing will permanently damage the battery and greatly reduce ride time  Refer to Page 7 Charging the Battery
Runs Intermittently	Loose connection(s)	Check the wires around the throttle and for other possible loose connections Contact your local Razor authorized service center for diagnosis and repair.  Replace - Throttle

For more troubleshooting tips, a list of available replacement parts or to locate an authorized Service Center in your area, visit our website at [www.razor.com](http://www.razor.com) or call toll free +1 866 467 2967 to speak to a live Customer Service Representative

**Need Help?** Visit our web site for replacement parts, product support, a list of authorized service centers in the US and customer service contact information at [www.razor.com](http://www.razor.com). Please have the product I.D. code (located on the white label of your product) available for better assistance. Additional Customer Service contact information is listed at the back of this manual.



# POCKET MOD BELLEZZA PARTS

Keep your Pocket Mod Bellezza running for years with genuine Razor parts. Visit our web site or e-mail us for more information on spare part availability. (Specifications subject to change without notice.)

- |                                       |  |                                      |
|---------------------------------------|--|--------------------------------------|
| 1. Handlebar Grip (Right/Left)        | 10. Front Wheel Complete               | 20. Motor (36V 500W )                |
| 2. Single Speed Twist Grip Throttle   | 11. Front Fork                         | 21. Rear Wheel Complete              |
| 2-1. Sleeve                           | 12. Front Seat Fairing                 | (See page 9 for hardware sequence)   |
| 3. Front Brake Lever Assembly (right) | 13. On/Off Switch                      | 22. Chain                            |
| 4. Handlebars                         | 14. Charger Port                       | 23. Chain Guard                      |
| 5. 6 mm Stem Bolt w/Wedge             | 15. Battery (3-12V/10Ah) w/30 Amp Fuse | 24. Chain Tensioner                  |
| 6. Rear Brake Lever assembly (left)   | 16. Seat w/Storage Compartment         | 25. Rear Seat Fairing w/Name Plate   |
| 7. Headset (Upper/Lower)              | 17. Control Module                     | 26. Rear Fairing w/Trim (Right/Left) |
| 8. Front Fairing w/Head Lamp Cover    | 18. Base Fairing                       |                                      |
| 9. Front Fairing Cover                | 19. Kickstand                          |                                      |

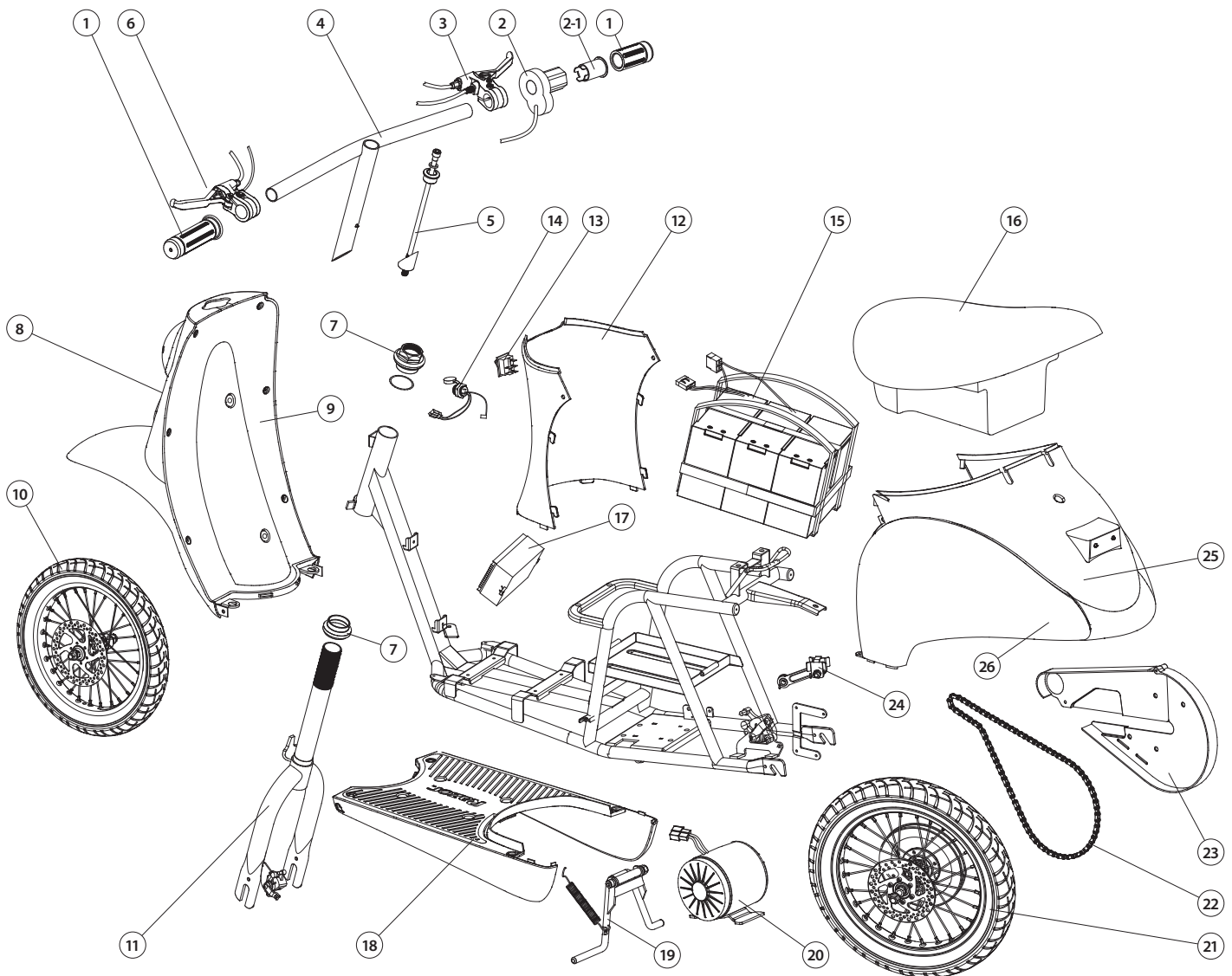

**Need Help?** Visit our web site for replacement parts, product support, a list of authorized service centers in the US and customer service contact information at [www.razor.com](http://www.razor.com). Please have the product I.D. code (located on the white label of your product) available for better assistance. Additional Customer Service contact information is listed at the back of this manual.

**NOTICE: INSURANCE**

**YOUR INSURANCE POLICIES MAY NOT PROVIDE COVERAGE FOR ACCIDENTS INVOLVING THE USE OF THIS SCOOTER/ELECTRIC RIDE-ON PRODUCT. TO DETERMINE IF COVERAGE IS PROVIDED, YOU SHOULD CONTACT YOUR INSURANCE COMPANY OR AGENT.**

## FCC COMPLIANCE

This device complies with Part 15 of the FCC Rules. Operation is subject to the following two conditions: (1) This device may not cause harmful interference, and (2) this device must accept any interference received, including interference that may cause undesired operation.

Note: This equipment has been tested and found to comply with the limits for a Class B digital device, pursuant to part 15 of the FCC Rules. These limits are designed to provide reasonable protection against harmful interference in a residential installation. This equipment generates, uses and can radiate radio frequency energy and, if not installed and used in accordance with the instructions, may cause harmful interference to radio communications. However, there is no guarantee that interference will not occur in a particular installation. If this equipment does cause harmful interference to radio or television reception, which can be determined by turning the equipment off and on, the user is encouraged to try to correct the interference by one or more of the following measures:

- Reorient or relocate the receiving antenna.
- Increase the separation between the equipment and receiver.
- Connect the equipment into an outlet on a circuit different from that to which the receiver is connected.
- Consult the dealer or an experienced radio/TV technician for help.

**⚠ WARNING:** Changes or modifications to this unit not expressly approved by Razor USA, could void the user's authority to operate the equipment.

## WARRANTY

### Razor Limited Warranty

The manufacturer warrants this product to be free of manufacturing defects for a period of 90 days from date of purchase. This Limited Warranty does not cover normal wear and tear, tire, tube or cables, or any damage, failure or loss caused by improper assembly, maintenance, storage or use of the Razor Pocket Mod Bellezza.

This Limited Warranty will be void if the product is ever:

- used in a manner other than for recreation or transportation;
- modified in any way;
- rented.

The manufacturer is not liable for incidental or consequential loss or damage due directly or indirectly to the use of this product.

Razor does not offer an extended warranty. If you have purchased an extended warranty, it must be honored by the store at which it was purchased.

For your records, save your original sales receipt with this manual and write the serial number below.

---

## CUSTOMER SERVICE CONTACT INFORMATION

**Need Help?** Visit our web site for replacement parts, product support, a list of authorized service centers in the US and customer service contact information at [www.razor.com](http://www.razor.com). Please have the product I.D. code (located on the white label of your product) available for better assistance. Additional Customer Service contact information is listed below:

### AMERICAS

Razor USA LLC  
P.O. Box 3610  
Cerritos, CA 90703  
USA

+1 866 467 2967  
Monday - Friday  
8:00 AM - 5:00 PM Pacific Time

### EUROPE

Razor USA LLC (Europe)  
Handelsweg 2  
2742 RD Waddinxveen  
Netherlands

+44 (0) 1202 672702

### ASIA

Razor USA LLC (Asia)  
P.O. Box 3610  
Cerritos, CA 90703  
USA

+81 50 7579 6622  
info@razor-asia.com

### DISTRIBUTED IN THE UK BY:

Re:creation Limited  
2 Meadows Business Park  
Station Approach, Blackwater  
Camberley, Surrey GU17 9AB  
United Kingdom

+44 (0) 118 973 6222 *Tel*  
+44 (0) 118 973 6220 *Fax*  
sales@recreationltd.co.uk

### DISTRIBUTED IN AUSTRALIA BY:

Funtastic Limited  
Level 2, Tower 2, Chadstone Place  
1341 Dandenong Road  
Chadstone VIC 3148  
Australia

+1 800 244 543  
info@funtastic.com.au

Printed in China for Razor USA LLC.

Copyright © 2003-2016 Razor USA, LLC. All rights reserved. Razor® and the Razor logo design are among the registered trademarks of Razor USA LLC in the United States and/or select foreign countries. Pocket Mod™ is a trademark of Razor USA LLC.