



## Black Label RTec™ Scooter



# OWNER'S MANUAL

**Read and understand this entire manual before allowing child to use this product! For assistance contact Razor.  
DO NOT RETURN TO STORE.**

NOTE: Manual illustrations are for demonstration purposes only.  
Illustrations may not reflect exact appearance of actual product.  
Specifications subject to change without notice.

Please have your product along with the 22 character product I.D. code with you before contacting Razor for warranty assistance and/or replacement parts.

Product I.D. Code: \_\_\_\_\_ - \_\_\_\_\_ - \_\_\_\_\_



# CONTENTS

Safety Warnings .....	1	Pre-Ride Checklist and Usage.....	4
Before You Begin.....	2	Repair and Maintenance.....	5
Assembly and Set-up.....	3	Warranty and Contact Information.....	6

# SAFETY WARNINGS

**! AN IMPORTANT MESSAGE TO PARENTS:** This manual contains important information. For your child's safety, it is your responsibility to review this information with your child and make sure that your child understands all warnings, cautions, instructions and safety topics. All children and preteens should ride with adult guidance at all times. Razor USA recommends that you periodically review and reinforce the information in this manual with younger riders, and that you are required to inspect and maintain your child's scooter to ensure their safety.

**! GENERAL WARNING:** Scooter riding can be a hazardous activity. Scooters can and are intended to move, and it is therefore possible to get into dangerous situations and/or lose control and/or fall. If such things occur you can be seriously injured or die. **LIKE ANY OTHER MOVING PRODUCT, USING A SCOOTER CAN BE A DANGEROUS ACTIVITY AND MAY RESULT IN INJURY OR DEATH EVEN WHEN USED WITH PROPER SAFETY PRECAUTIONS. USE AT YOUR OWN RISK AND USE COMMON SENSE.**

- Always wear safety equipment, such as helmet, knee pads and elbow pads. Always wear a helmet when riding your scooter and keep the chinstrap securely buckled.
- Always wear closed toe shoes.
- Ride on smooth, paved surfaces away from motor vehicles.
- Avoid sharp bumps, drainage grates, and sudden surface changes. Scooter may suddenly stop.
- Avoid streets and surfaces with water, sand, gravel, dirt, leaves, and other debris. Wet weather impairs traction, braking, and visibility.
- Do not ride at night.
- Brake will get hot from continuous use. Do not touch after braking.
- Avoid excessive speed associated with downhill rides.
- Adults must assist children in the initial assembly and/or adjustment procedures to adjust handlebar scooter.
- Obey all local traffic and scootering laws and regulations.
- Watch out for pedestrians.
- Do not exceed 220 lb (100 kg) total weight on the Black Label R Tec.
- A parent's decision to allow his or her child to ride this product should be based on the child's maturity, skill and ability to follow rules.
- Do not allow children under age six (6) to use the Black Label R Tec scooter. Black Label R Tec scooters are for children ages six (6) and above. All children and preteens should ride with adult guidance at all times.
- Rider weight does not necessarily mean a child's size is appropriate to fit or maintain control of the scooter.

## ACCEPTABLE RIDING PRACTICES AND CONDITIONS

Direct parental supervision is required. Scooters are meant to be used only in controlled environments free of potential traffic hazards and not on public streets. Do not allow your child to ride a scooter in any areas where vehicle traffic is present. Child must maintain a hold on the handlebars at all times. Never allow more than one child at a time to ride a scooter. Never use near steps, sloped driveways, hills, roadways, alleys or swimming pool areas. Adults must not allow children to assist in assembling the scooter.

Do not ride a scooter in wet weather. Scooters are intended for use on solid, flat, clean and dry surfaces, such as pavement or level ground without loose debris, such as rocks or gravel. Wet, slick or uneven and rough surfaces may impair traction and contribute to possible accidents. Do not ride a scooter in mud, ice, puddles or water. Avoid excessive speeds that can be associated with downhill rides. Never risk damaging surfaces, such as carpet or flooring, by use of a scooter indoors. Do not ride at night or when visibility is impaired.

## PROPER RIDING ATTIRE

Always ensure rider is wearing proper protective equipment, such as an approved safety helmet. A helmet may be legally required by local law or regulation in your area. A rider should always wear shoes and keep shoelaces tied and out of the way of the wheels. Never ride barefooted or in sandals. Knee pads and elbow pads are recommended.

**! WARNING:** ALWAYS INSPECT SCOOTER PRIOR TO RIDING. Properly inspecting and maintaining your scooter can reduce the risk of injury. Always inspect your scooter before riding and regularly maintain it. Check and secure all fasteners before every ride. Replace worn or broken parts immediately.

**! WARNING:** CHECK LOCAL LAWS REGARDING SCOOTER USE. Check local laws and regulations to see where and how you may use your Razor scooter legally. In many states and local areas scooter riders are required BY LAW to wear a helmet. Check local laws and regulations regarding laws governing helmet use and scooter operation in your area.

**FAILURE TO USE COMMON SENSE AND HEED THE ABOVE WARNINGS FURTHER INCREASES RISK OF SERIOUS INJURY. USE AT YOUR OWN RISK AND WITH APPROPRIATE AND SERIOUS ATTENTION TO SAFE OPERATION. USE CAUTION.**

## BEFORE YOU BEGIN

Remove contents from box. Inspect the contents of the box for scratches and/or dents that may have occurred during shipping. Because your scooter was partially assembled and packed at the factory, there should not be any problems, even if the box has a few scars or dents.

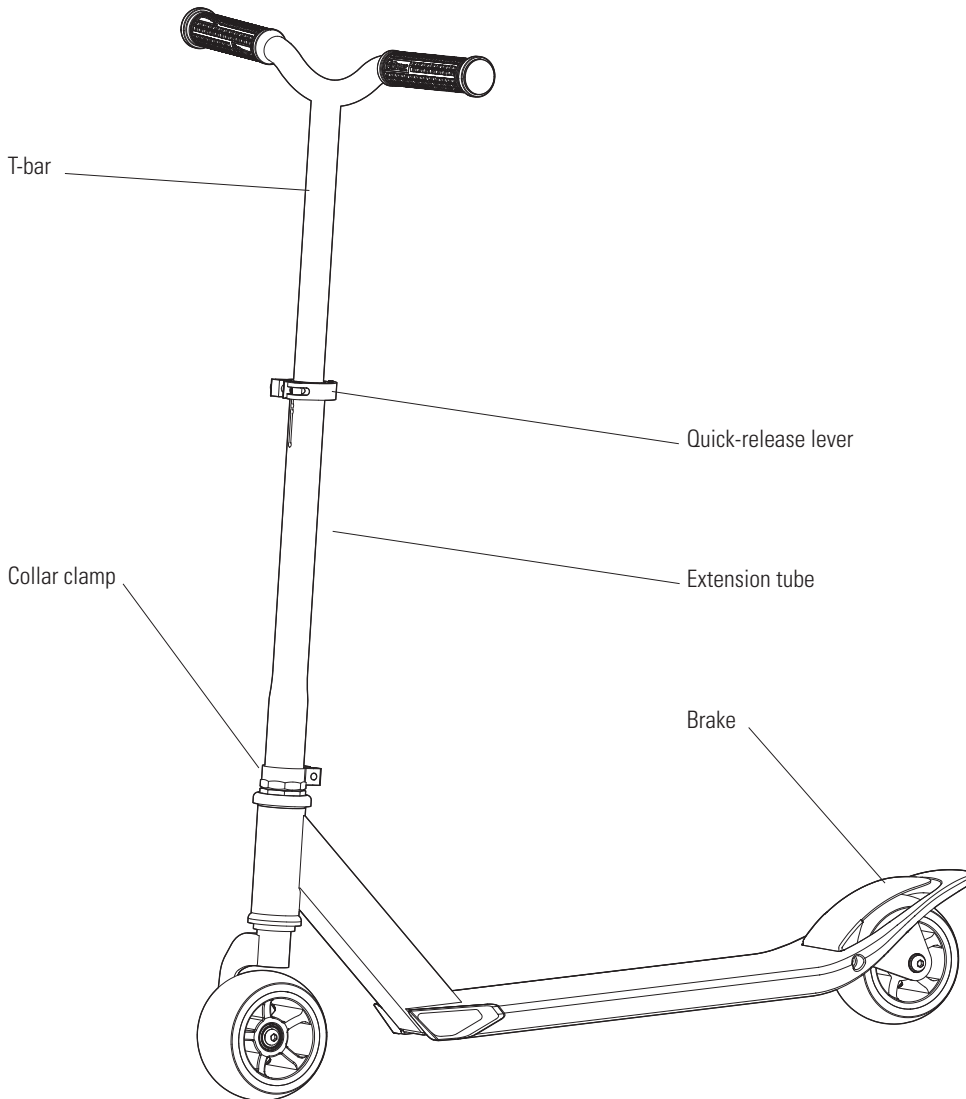

### Required Tools

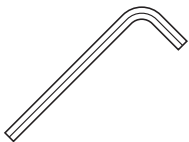

5 mm  
Allen wrench



### WARNING:

**DO NOT USE NON-RAZOR PRODUCTS WITH YOUR SCOOTER.** Razor scooters have been built to certain Razor design specifications. The original equipment supplied at the time of sale was selected on the basis of its compatibility with the frame, fork and all other parts. Certain aftermarket products may not be compatible and will void the warranty.

### Product ID Locations:

1. Side of deck plate
2. Box - side of UPC (not shown)

### Box Contents:

- Scooter
- Allen wrench
- Owner's manual

**Need Help?** Visit our web site for replacement parts, product support, a list of authorized service centers in the US and customer service contact information at [www.razor.com](http://www.razor.com). Please have the product I.D. code (located on the white label of your product) available for better assistance. Additional Customer Service contact information is listed at the back of this manual.

# ASSEMBLY AND SET-UP

## □ Attaching and Adjusting the Handlebars

Required Tool: 5 mm Allen wrench

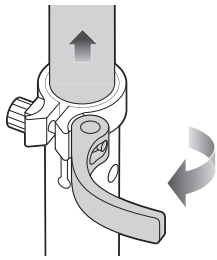

**1** Open the quick-release lever and fully extend the T-bar to the maximum height.

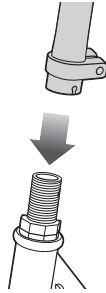

**2** Loosen the collar clamp. Insert T-bar into the fork until it bottoms out on the headset locknut.

**Note:** If necessary, carefully twist the T-bar while pushing downward.

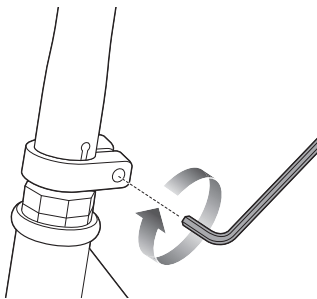

**3** With the front wheel pointed straight ahead and the handlebars square to the front wheel and the Razor logo facing the front, tighten the clamp as shown. Tighten securely.

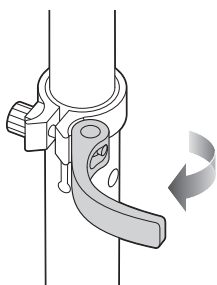
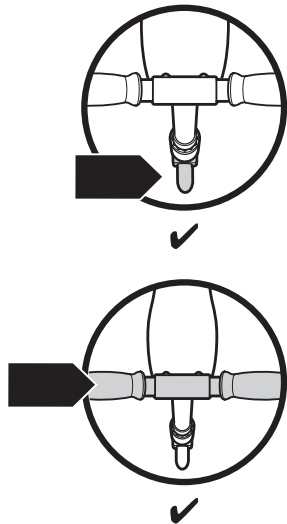

**4** To adjust the height of the handlebars, open the quick-release lever and slide the T-bar to the desired position. Resecure the quick release lever to lock into place. When the T-bar is raised to the maximum height, depress the push button located directly below the quick release lever to unlock the T-bar.

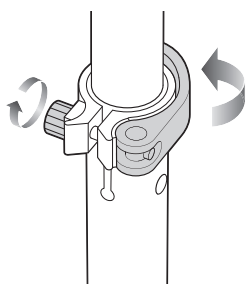

**Note:** The tension of the quick-release lever can be adjusted by manually tightening or loosening the Allen bolt. Be careful not to over-tighten. You should always be able to open and close the quick-release lever by hand and the T-bar should slide freely when the quick-release is open unless T-bar is fully extended.

**⚠ WARNING:** Failure to properly install and tighten the collar clamp may cause the rider to lose control and fall. If you are having difficulty understanding these instructions, please contact Razor Customer Service for assistance.

**⚠ WARNING:** Failure to properly secure the quick-release lever may cause the T-bar to telescope up or down while riding and may cause you to lose control and fall.

**Need Help?** Visit our web site for replacement parts, product support, a list of authorized service centers in the US and customer service contact information at [www.razor.com](http://www.razor.com). Please have the product I.D. code (located on the white label of your product) available for better assistance. Additional Customer Service contact information is listed at the back of this manual.

## PRE-RIDE CHECKLIST



### Loose Parts

Check and secure all fasteners before every ride. Make sure the collar clamp and quick release lever are locked properly in place before riding.



### Replacement Parts

Replace worn or broken parts immediately. Call 1-866-467-2967 for parts or visit [www.razor.com](http://www.razor.com).



### Safety Gear

Always wear proper protective equipment, such as an approved safety helmet, elbow pads and kneepads. Always wear shoes (lace-up with rubber soles) and keep shoelaces tied and out of the way of the wheels. Never ride barefooted or in sandals.



### Be Careful!

You will see people on TV and maybe even people you know doing tricks and stunts. These are people who have been practicing on scooters for a very long time. Don't try something until you are ready. Avoid steep inclines and don't ride too fast — you can lose control and fall. Skateboard parks are not designed for scooters. Never ride in traffic or on the street and watch your surroundings for pedestrians, bikers, boarders and skaters.

Maintain a hold on the handlebars at all times.

## USAGE

### How to Ride

Place one foot on the baseboard, push forward with the other foot. Steer with both hands on the handlebars. For enhanced cornering, lean slightly into the direction of the turn. For controlled stops, apply the brake by stepping on the rear brake. Razor recommends that you practice applying the brake at various speeds and in an open area free from obstructions before riding your scooter around others.

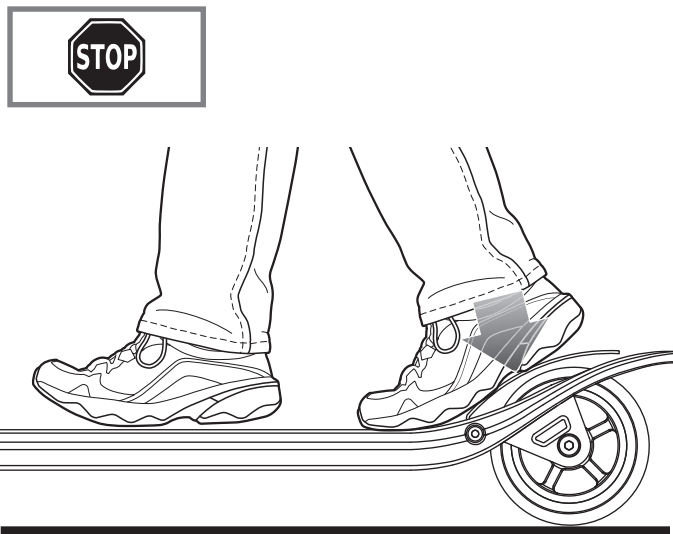

**Need Help?** Visit our web site for replacement parts, product support, a list of authorized service centers in the US and customer service contact information at [www.razor.com](http://www.razor.com). Please have the product I.D. code (located on the white label of your product) available for better assistance. Additional Customer Service contact information is listed at the back of this manual.

## REPAIR AND MAINTENANCE

### ❑ Collar Clamp

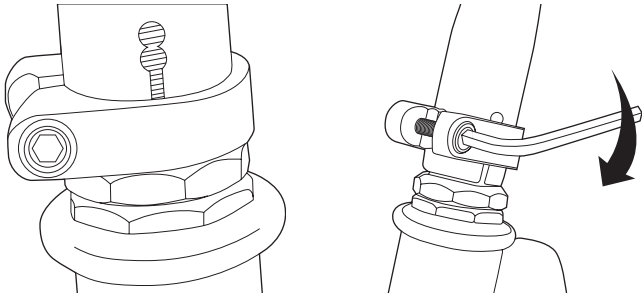

Using a 5 mm Allen wrench, check that the collar clamp bolt are tightened securely. This item is tightened and quality inspected at the factory, but there is a slight chance that the effects of shipping or handling may have caused the bolt to loosen.

### ❑ Wheels and Bearings

Under normal circumstances and conditions, Razor wheels and wheel bearings are maintenance free. Nonetheless, it is the responsibility of the owner or guardian to periodically inspect the wheels for wear and tear, the axle for proper tightness, bearings for side-to-side play, and loose parts. When a wheel or wheel bearing develops play, this is an indication of excess wear, and replacement is necessary. Replace immediately with only genuine Razor wheels. Worn wheels/bearings are considered normal wear-and-tear and are not covered by the Razor Warranty. Wheels other than genuine Razor wheels may not be compatible with your Razor scooter. The use of anything other than genuine Razor replacement parts may affect your safety and will void your warranty.

### ❑ Cleaning Your Scooter

Wipe with a damp cloth to remove dirt and dust. Do not use industrial cleaners or solvents as they may damage the surfaces. Do not use alcohol, alcohol-based or ammonia-based cleaners as they may damage or dissolve the plastic components or soften the decals or decal adhesive.

### **!** WARNING:

Failure to properly install and/or tighten the collar clamp may cause the rider to lose control and fall. If you are having difficulty understanding these instructions, please contact Razor Customer Service for assistance.

### **!** WARNING:

Wheelies and other stunt-type riding reduces your ability to maneuver and control your scooter.

**Need Help?** Visit our web site for replacement parts, product support, a list of authorized service centers in the US and customer service contact information at [www.razor.com](http://www.razor.com). Please have the product I.D. code (located on the white label of your product) available for better assistance. Additional Customer Service contact information is listed at the back of this manual.

## WARRANTY

### Razor Limited Warranty

The manufacturer warrants this product to be free of manufacturing defects for a period of 6 months from date of purchase. This Limited Warranty does not cover normal wear and tear, or any damage, failure or loss caused by improper assembly, maintenance, or storage.

This Limited Warranty will be void if the product is ever:

- used in a manner other than for recreation;
- modified in any way;
- rented.

The manufacturer is not liable for incidental or consequential loss or damage due directly or indirectly to the use of this product.

Razor does not offer an extended warranty. If you have purchased an extended warranty, it must be honored by the store at which it was purchased.

For your records, save your original sales receipt with this manual.

---

## CUSTOMER SERVICE CONTACT INFORMATION

**Need Help?** Visit our web site for replacement parts, product support, a list of authorized service centers in the US and customer service contact information at [www.razor.com](http://www.razor.com). Please have the product I.D. code (located on the white label of your product) available for better assistance. Additional Customer Service contact information is listed below:

### UNITED STATES

Razor USA LLC  
P.O. Box 3610  
Cerritos, CA 90703  
USA

+1 866 467 2967  
Monday - Friday  
8:00 AM - 5:00 PM Pacific Time

### EUROPE

Razor USA (Europe)  
Handelsweg 2  
2742 RD Waddinxveen  
Netherlands

+44 (0) 120 267 2702

### ASIA

Razor USA (Asia)  
P.O. Box 3610  
Cerritos, CA 90703  
USA

+81 50 7579 6622  
[info@razor-asia.com](mailto:info@razor-asia.com)

### DISTRIBUTED IN THE UK BY:

Re:creation Limited  
2 Meadows Business Park  
Station Approach, Blackwater  
Camberley, Surrey GU17 9AB  
United Kingdom

+44 (0) 118 973 6222 Tel  
+44 (0) 118 973 6220 Fax  
[sales@recreationltd.co.uk](mailto:sales@recreationltd.co.uk)

### DISTRIBUTED IN AUSTRALIA BY:

Funtastic Limited  
Level 2, Tower 2, Chadstone Place  
1341 Dandenong Road  
Chadstone VIC 3148  
Australia

+1 800 244 543

Printed in China for:  
Razor USA LLC  
PO Box 3610  
Cerritos, CA 90703

Copyright © 2003-2014 Razor USA, LLC. All rights reserved. RAZOR and the Razor logo design are among the registered trademarks of Razor USA LLC in the United States and/or select foreign countries. R Tec™ is a trademark of Razor USA LLC.