



POWERWING™



OWNER'S MANUAL

**Read and understand this entire manual before riding!
For assistance contact Razor®. DO NOT RETURN TO STORE.**

**NOTE: Manual illustrations are for demonstration purposes only.
Illustrations may not reflect exact appearance of actual product.
Specifications subject to change without notice.**

Item Number:
Black 20036090
Silver 20036011
DLX 20036099

CONTENTS

Safety Warnings	1	PowerWing™ Parts	5
Before You Begin.....	2	Warranty	6
Set-Up and Usage.....	3-4		

SAFETY WARNINGS

! AN IMPORTANT MESSAGE TO PARENTS: This manual contains many warnings and cautions concerning the consequences of failing to maintain, inspect or properly use your PowerWing™. Because any incident can result in serious injury or even death, we do not repeat the warning of potential serious injury or death each time such a possibility is mentioned.

! GENERAL WARNING: Riding the PowerWing™ can be a hazardous activity. Certain conditions may cause the equipment to fail without fault of the manufacturer. Like other wheeled products, the PowerWing™ can and is intended to move, and it is therefore possible to lose control, fall off and/or get into dangerous situations that no amount of care, instruction or expertise can eliminate. If such things occur, your child can be seriously injured or die, even when using safety equipment and other precautions. **USE COMMON SENSE.**

APPROPRIATE RIDER USE AND PARENTAL SUPERVISION

Direct adult supervision is required at all times. This manual contains important safety information. It is your responsibility to review this information and make sure that all children obey all warnings, cautions, instructions and safety topics and assure that young riders are able to safely use this product. Razor® recommends that you periodically review and reinforce the information in this manual with young riders, and that you inspect and maintain your children's product to insure their safety.

The recommended rider age of 5 years and older for PowerWing™ is only an estimate, and can be affected by the rider's size, weight or ability. Any child unable to fit comfortably on the PowerWing™ should not attempt to ride it.

A parent's decision to allow his or her child to ride this product should be based on the child's maturity, skill and ability to follow rules.

Do not exceed 143 LBS (65 kilograms) on the PowerWing™ and 180 pounds (81 kilograms) on the PowerWing™ DLX.

Rider weight does not necessarily mean a child's size is appropriate to fit or maintain control of the PowerWing™.

Refer to the section on safety for additional warnings.

ACCEPTABLE RIDING PRACTICES AND CONDITIONS

Direct parental supervision is required. The PowerWing™ is meant to be used only in controlled environments free of potential traffic hazards and not on public streets. Do not allow your child to ride the PowerWing™ in any areas where vehicle traffic is present. Child must maintain a hold on the handlebars at all times. Never allow more than one child at a time to ride the PowerWing™. Never use near steps, sloped driveways, hills, roadways, alleys or swimming pool areas. Keep fingers and other body parts away from the product when folding or unfolding. Adults must not allow children to assist in folding or unfolding the PowerWing™.

Do not ride the PowerWing™ in wet weather. The PowerWing™ is intended for use on solid, flat, clean and dry surfaces such as pavement or level ground without loose debris such as rocks or gravel. Wet, slick or uneven and rough surfaces may impair traction and contribute to possible accidents. Do not ride the PowerWing™ in mud, ice, puddles or water. Avoid excessive speeds that can be associated with downhill rides. Never risk damaging surfaces such as carpet or flooring by use of a PowerWing™ indoors. Do not ride at night or when visibility is impaired.

PROPER RIDING ATTIRE

Always ensure child is wearing proper protective equipment such as an approved safety helmet. A helmet may be legally required by local law or regulation in your area. A child should always wear shoes, never ride barefooted or in sandals, and keep shoelaces tied and out of the way of the wheels.

FAILURE TO USE COMMON SENSE AND HEED THE ABOVE WARNINGS INCREASES RISK OF SERIOUS INJURY. USE WITH APPROPRIATE CAUTION AND SERIOUS ATTENTION TO SAFE OPERATION.

! WARNING: ALWAYS INSPECT POWERWING™ PRIOR TO RIDING. Properly inspecting and maintaining your scooter can reduce the risk of injury. Always inspect your PowerWing™ before riding and regularly maintain it.

! WARNING: CHECK LOCAL LAWS REGARDING POWERWING™ USE. Check local laws and regulations to see where and how you may use your Razor PowerWing™ legally. In many states and local areas PowerWing™ riders are required BY LAW to wear a helmet. Check local laws and regulations regarding laws governing helmet use and PowerWing™ operation in your area.

BEFORE YOU BEGIN

Remove contents from box and check parts against part diagram below. Remove the foam separators that protect the components from damage during shipping. Inspect the contents of the box for scratches in the paint, dents or kinked cables that may have occurred during shipping. Because the PowerWing™ is partially assembled and packed at the factory, there should not be any problems, even if the box has a few scars or dents.

Estimated Assembly and Set-Up Time

Allow up to 15–20 minutes for assembly.

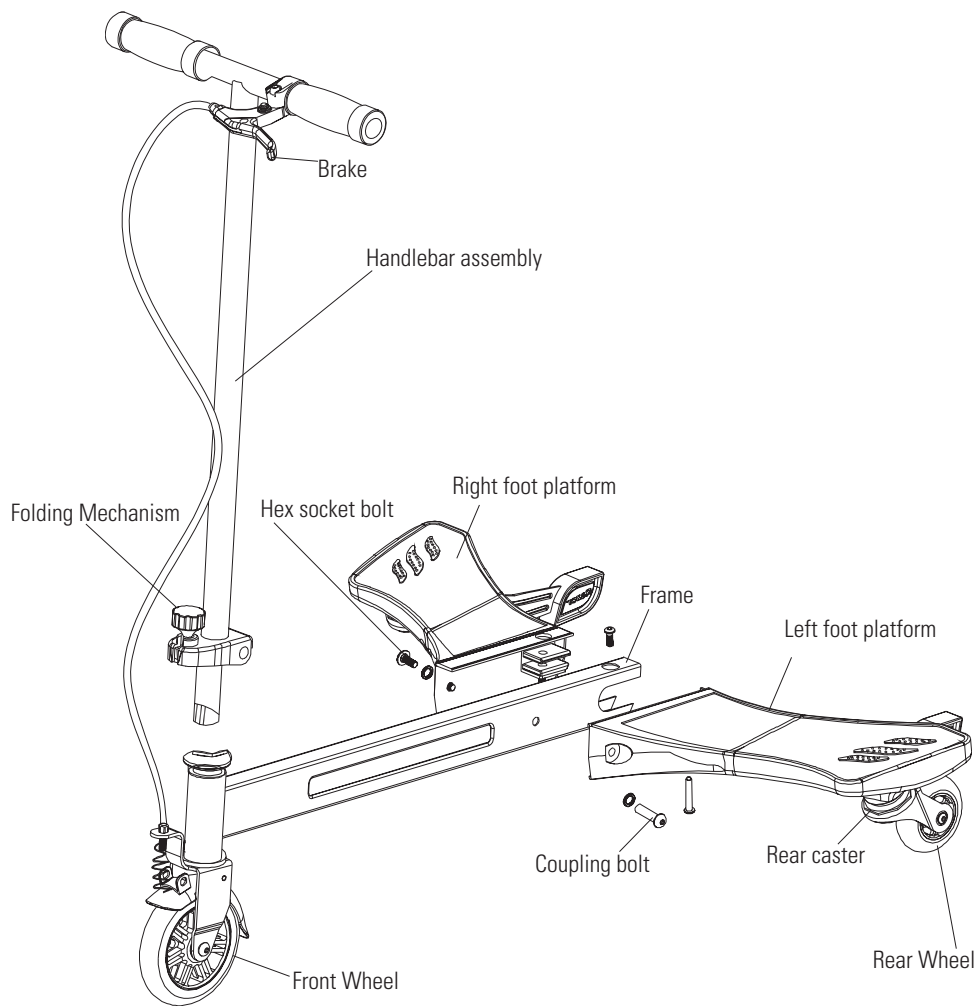

Required Tools

Tools needed to assemble are included.

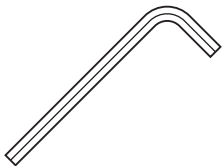

(2) 5mm hexagonal key
wrenches
(included)

WARNING: DO NOT USE NON-RAZOR PRODUCTS WITH YOUR POWERWING™.

The PowerWing™ has been built to certain Razor® design specifications. The original equipment supplied at the time of sale was selected on the basis of its compatibility with the frame, fork and all other parts. Certain aftermarket products may or may not be compatible.

Need Help? Visit our web site for replacement parts and product support at www.razor.com or call toll-free at 866-467-2967 Monday - Friday 8:00 AM - 5:00 PM Pacific Time.

SET-UP AND USAGE

□ Attaching the Foot Platforms

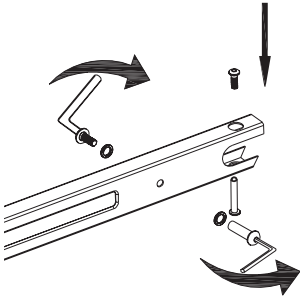

1 Remove black plastic protector at the end of the frame. Using two 5mm hexagonal wrenches, remove the two hexagonal bolts and the two coupling bolts from the frame.

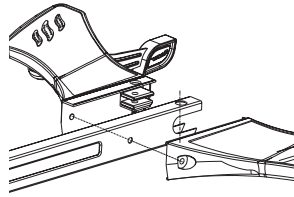

2 Remove black plastic protector at the end of the platform. Position the right and left foot platforms up to the frame and align holes.

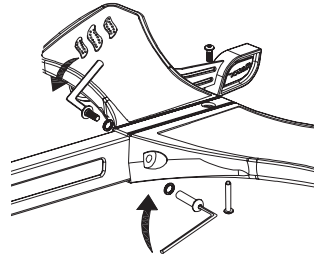

3 Insert the two coupling bolts and two hexagonal bolts. Starting underneath with the bolt on the back. Turn product over and insert the next set of bolts. Tighten with two 5mm hexagonal wrenches.

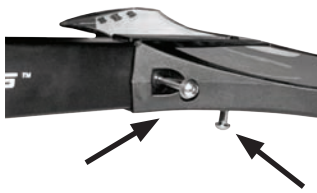

4a If necessary, use a mallet / hammer to tap the two coupling bolts until they are all the way through the platforms.

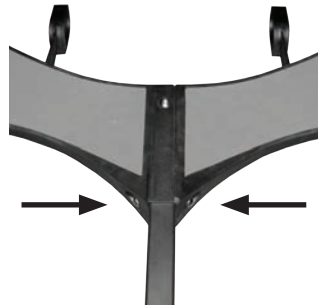

4b The platforms should now be snug against the frame.

SET-UP AND USAGE

□ Attaching the Handlebars

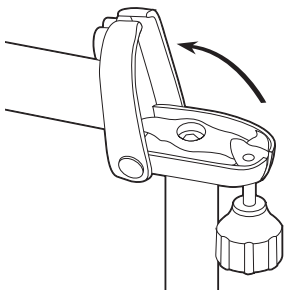

1 Remove the plastic protector covering the wedge and loosen the black folding knob and swing to the 6 o'clock position to unfold the handlebar stem.



2 Insert the handlebar stem into the front fork. You may have to loosen the wedge to allow it to slip into the front fork.

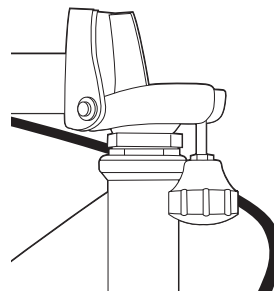

3 Slide the handlebar stem down into the front fork until it fits snugly into the lock nut on the headset.

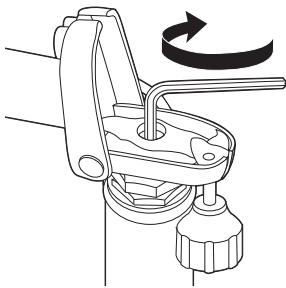

4 Using a 5mm hexagonal key wrench to tighten the stem bolt. The stem bolt is properly tightened when the handlebars cannot be twisted out of alignment with the front wheel. Make sure the handlebars are in line with the front wheel before tighten stem bolt all the way.

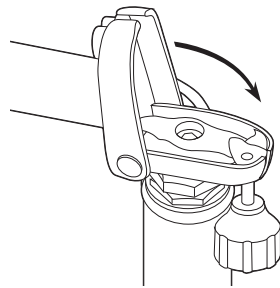

5 Bring the handlebar stem back to the upright position.

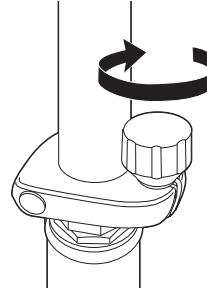

6 Swing the black folding knob to the 12 o'clock position and tighten by hand until handlebars are secure.

⚠ WARNING: Failure to properly tighten the wedge may allow the handlebars to dislodge while riding and may cause you to lose control and fall. When correctly tightened, the handlebars will not rotate out of alignment with the front wheel under normal circumstances.

⚠ WARNING: Keep your fingers clear of the pivoting mechanism when folding or unfolding the PowerWing™, and make sure others are standing clear.

Note: The cable and wire assembly from the handlebar must not wrap around the steering tube or handlebar as shown in step 3. Sharp bends or twisting of the brake cable can cause the brake to malfunction.

□ Adjusting the Brake

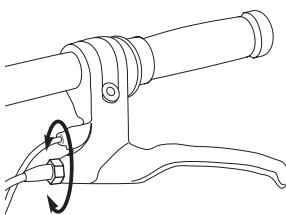

1 To adjust the brake cable wire, thread the brake lever adjuster in or out 1/4 to 1/2 turn until the desired cable tension is attained.

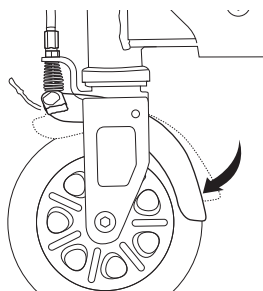

2 Squeeze the hand lever to test the brake to make sure it is working properly. The front fender should clamp down and rub against the front wheel. If brake is not working properly, proceed to the next step.

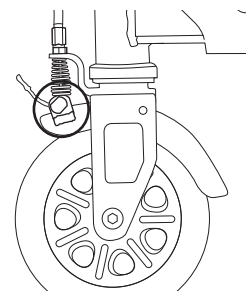

3 If the brake is too tight or too loose, use a 8mm open wrench and a 3mm allen wrench to make adjustments as needed.

Need Help? Visit our web site for replacement parts and product support at www.razor.com or call toll-free at 866-467-2967 Monday - Friday 8:00 AM - 5:00 PM Pacific Time.

POWERWING PARTS

Keep your PowerWing™ running for years with genuine Razor parts. Visit our web site www.razor.com to purchase replacement parts. (Specifications subject to change without notice.)

- | | | | | | | | |
|---|----------------------------------|-------|-----------------------------|--------|------------------------------|--------|-----------------------------|
| 1 | Handlebar Stem | 8 | 120mm Front Wheel | 10 - 1 | Brake Cable Adjust Screw | 13 | Foot Platform (Right/Left) |
| 2 | Handlebar Grip (2) | 8 - 1 | Washer (Front Wheel) | 10 - 2 | Brake Spring | 14 | Platform Cover (Right/Left) |
| 3 | Brake Lever Assembly | 8 - 2 | 608zz Bearing (Front Wheel) | 10 - 3 | Brake Mounting Coupling Bolt | 15 | Stability Bar (Right/Left) |
| 4 | Brake Cable Guide | 8 - 3 | Front Wheel Spacer | 10 - 4 | Pivoting Mechanism | 15 - 1 | 5mm Hexagonal Bolt |
| 5 | Folding Knob | 9 | Front Axle Bolt | 11 | Coupling Bolt (Footstepper) | 16 | Caster |
| 6 | Wedge | 10 | Front Fork with Fender | 12 | Coupling Bolt | 17 | 64mm Rear Wheel |
| 7 | Headseat w/Bearing (Upper/Lower) | | | | | | |

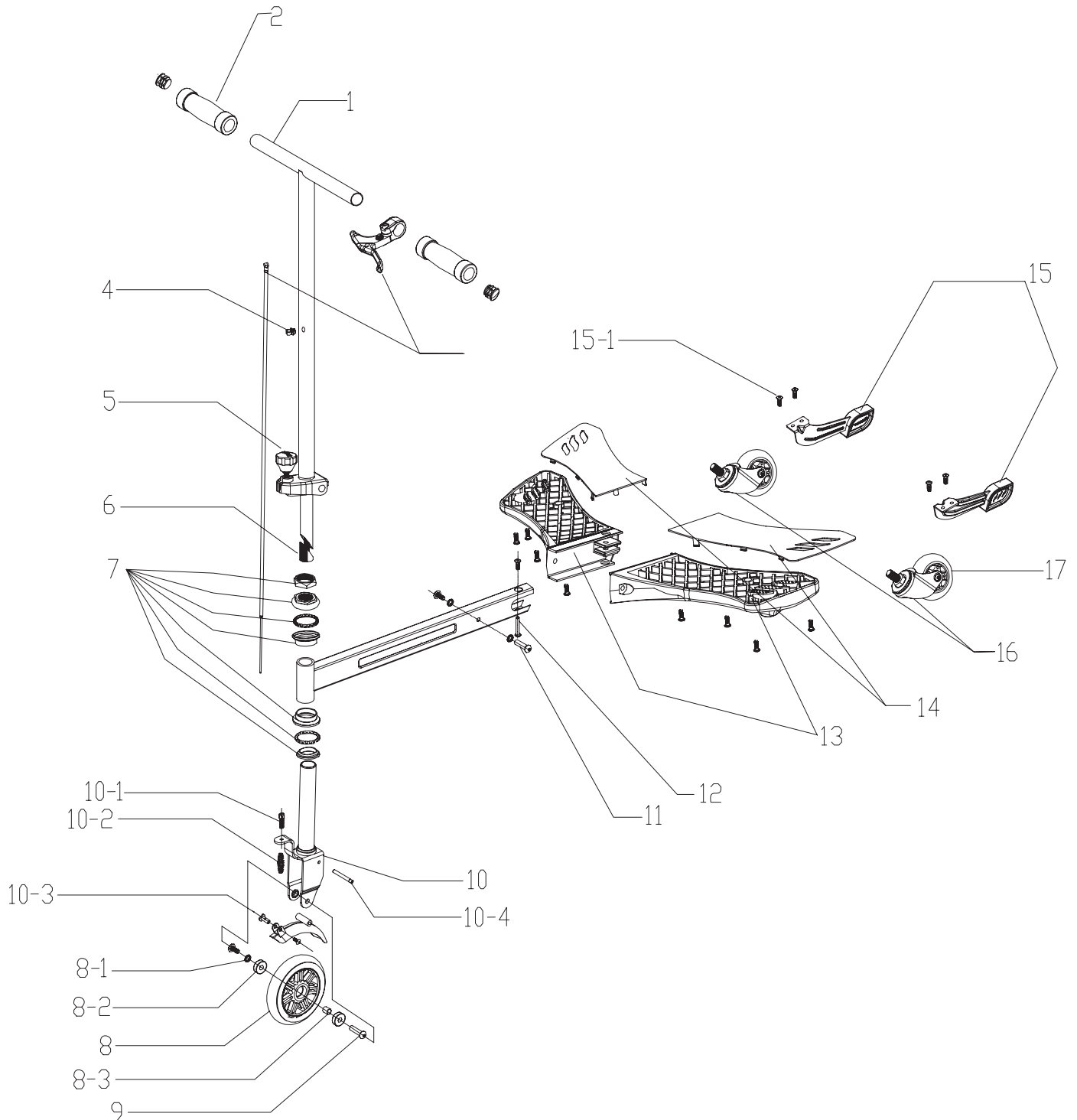

SAFETY REMINDERS

PRE-RIDE CHECKLIST



Loose Parts

Check and secure all fasteners before every ride. Make sure the steering bolts and foot steppers are tight. There should not be any unusual rattles or sounds from loose parts or broken components. If you are not sure, ask an experienced mechanic to check.



Brake

Check the brake for proper function. When you squeeze the lever, the brake should provide positive braking action.



Frame, Fork and Handlebars

Check for cracks or broken connections. Although broken frames are rare, it is possible for an aggressive rider to run into a curb or wall and wreck and bend or break a frame. Get in the habit of inspecting yours regularly.



Safety Gear

Always wear proper protective equipment such as an approved safety helmet, elbow pads and kneepads. Always wear shoes (lace-up shoes with rubber soles), never ride barefooted or in sandals, and keep shoelaces tied and out of the way of the wheels.



DO NOT RETURN TO STORE

Failure to follow these instructions may damage your product and void your warranty.

WARRANTY

Razor Limited Warranty

The manufacturer warrants this product to be free of manufacturing defects for a period of 6 months from date of purchase. This Limited Warranty does not cover normal wear and tear, wheels, or any damage, failure or loss caused by improper assembly, maintenance, or storage or use of the Razor® PowerWing™.

This Limited Warranty will be void if the product is ever

- used in a manner other than for recreation;
- modified in any way;
- rented.

The manufacturer is not liable for incidental or consequential loss or damage due directly or indirectly to the use of this product.

Razor® does not offer an extended warranty. If you have purchased an extended warranty, it must be honored by the store at which it was purchased.

For your records, save your original sales receipt with this manual.

Item Number:

Black 20036090

Silver 20036011

Need Help? Visit our web site for replacement parts and product support at www.razor.com or call toll-free at 866-467-2967 Monday - Friday 8:00 AM - 5:00 PM Pacific Time.

U.S. Patent 7,597,334 B2

Printed in China for:
Razor USA LLC
PO Box 3610
Cerritos, CA 90703

Copyright © 2003-2010 Razor USA, LLC. All rights reserved. RAZOR® and the Razor Logo Design are among the registered trademarks of Razor USA LLC in the United States and/or select foreign countries. PowerWing™ is a trademark of Razor USA LLC.