



**GRAFFITI**<sup>TM</sup>  
**SCOOTER**



# OWNER'S MANUAL

**Read and understand this entire manual before  
allowing child to use this product!  
For assistance contact Razor. DO NOT RETURN TO STORE.**

**NOTE: Manual illustrations are for demonstration purposes only. Illustrations may not reflect exact appearance of actual product. Specifications subject to change without notice.**

# CONTENTS

Safety Warnings .....	1	Scooter Parts List .....	6
Before You Begin.....	2	Safety Tips .....	7
Set Up and Usage Instructions.....	3-4	Warranty .....	7
Check Before Riding.....	5		

## SAFETY WARNINGS

**! AN IMPORTANT MESSAGE TO PARENTS:** This manual contains important information. For your child's safety, it is your responsibility to review this information with your child and make sure that your child understands all warnings, cautions, instructions and safety topics. Razor USA recommends that you periodically review and reinforce the information in this manual with younger riders and that you are required to inspect and maintain your child's scooter to insure their safety.

**NOTE:** The age recommendation for the Graffiti™ scooter is higher than that of a "basic" scooter because using the chalk device when riding may be more complicated. Make sure your child is ready!

**! GENERAL WARNING:** Scooter riding can be a hazardous activity. Scooters can and are intended to move and it is therefore possible to get into dangerous situations and/or lose control and/or fall. If such things occur you can be seriously injured or die. **LIKE ANY OTHER MOVING PRODUCT, USING A SCOOTER CAN BE A DANGEROUS ACTIVITY AND MAY RESULT IN INJURY OR DEATH EVEN WHEN USED WITH PROPER SAFETY PRECAUTIONS. USE AT YOUR OWN RISK AND USE COMMON SENSE.**

- Do not allow children under age six (6) to use the scooter. Children under age eight (8) should ride with adult supervision at all times. All children and preteens should ride with adult guidance at all times.
- **Always pay attention to where you are going; do not allow use of the chalk marking device to distract you from safe riding practices.**
- Always wear safety equipment such as helmet, knee pads and elbow pads. Always wear a helmet when riding your scooter and keep the chin-strap securely buckled.
- Always wear shoes.
- Ride on smooth, paved surfaces away from motor vehicles.
- Avoid sharp bumps, drainage grates, and sudden surface changes. Scooter may suddenly stop.
- Avoid streets and surfaces with water, sand, gravel, dirt, leaves, and other debris. Wet weather impairs traction, braking, and visibility.
- Do not ride at night.
- Brake will get hot from continuous use. Do not touch after braking.
- Avoid excessive speed associated with downhill rides.
- Adults must assist children in the initial adjustment procedures to unfold scooter, adjust handlebar and steering to height, and finally to fold scooter.
- Obey all local traffic and scootering laws and regulations.
- Watch out for pedestrians.
- Do not exceed 143 pounds (65 kilograms) total weight on the Graffiti™ scooter.
- Rider weight does not necessarily mean a child's size is appropriate to fit or maintain control of the scooter.
- A parent's decision to allow his or her child to ride this product should be based on the child's maturity, skill and ability.

### ACCEPTABLE RIDING PRACTICES AND CONDITIONS

Direct parental supervision is required. Scooters are meant to be used only in controlled environments free of potential traffic hazards and not on public streets. Do not allow your child to ride a scooter in any areas where vehicle traffic is present. Child must maintain a hold on the handlebars at all times. Never allow more than one child at a time to ride a scooter. Never use near steps, sloped driveways, hills, roadways, alleys or swimming pool areas. Keep fingers and other body parts away from the product when folding or unfolding. Adults must not allow children to assist in folding or unfolding the scooter.

Do not ride a scooter in wet weather. Scooters are intended for use on solid, flat, clean and dry surfaces such as pavement or level ground without loose debris such as rocks or gravel. Wet, slick or uneven and rough surfaces may impair traction and contribute to possible accidents. Do not ride a scooter in mud, ice, puddles or water. Avoid excessive speeds that can be associated with downhill rides. Never risk damaging surfaces such as carpet or flooring by use of a scooter indoors. Do not ride at night or when visibility is impaired.

When toggling the chalking mechanism from the OFF to ON position, avoid sustained downward pressure against the lever mechanism. Sustained downward pressure can cause the springs to rub directly on the ground. Sustained rubbing (20+ minutes) will wear down the springs which could cause the springs to break.

### CLEAN-UP AND CARE RELATED TO CHALK

The chalk provided by Razor with this product is non-toxic. It is designed and intended for use on hardened asphalt or concrete surfaces, and may be washed off with water. Use of a brush or broom may assist in removal. Chalk contains colorants which may cause stains to clothing or other household items, and should not be used on surfaces less than six months old.

### PROPER RIDING ATTIRE

Always ensure child is wearing proper protective equipment such as an approved safety helmet. A helmet may be legally required by local law or regulation in your area. A child should always wear shoes, never ride barefooted or in sandals, and keep shoelaces tied and out of the way of the wheels.

**FAILURE TO USE COMMON SENSE AND HEED THE ABOVE WARNINGS FURTHER INCREASES RISK OF SERIOUS INJURY. USE AT YOUR OWN RISK AND WITH APPROPRIATE AND SERIOUS ATTENTION TO SAFE OPERATION. USE CAUTION.**

**! WARNING:** ALWAYS INSPECT SCOOTER PRIOR TO RIDING. Properly inspecting and maintaining your scooter can reduce the risk of injury. Always inspect your scooter before riding and regularly maintain it.

**! WARNING:** CHECK LOCAL LAWS REGARDING SCOOTER USE. Check local laws and regulations to see where and how you may use your Razor scooter legally. In many states and local areas scooter riders are required BY LAW to wear a helmet. Check local laws and regulations regarding laws governing helmet use and scooter operation in your area.

## BEFORE YOU BEGIN

Remove contents from box. Inspect the contents of the box for scratches in the paint and/or dents that may have occurred during shipping. Because your scooter was assembled and packed at the factory, there should not be any problems, even if the box has a few scars or dents.

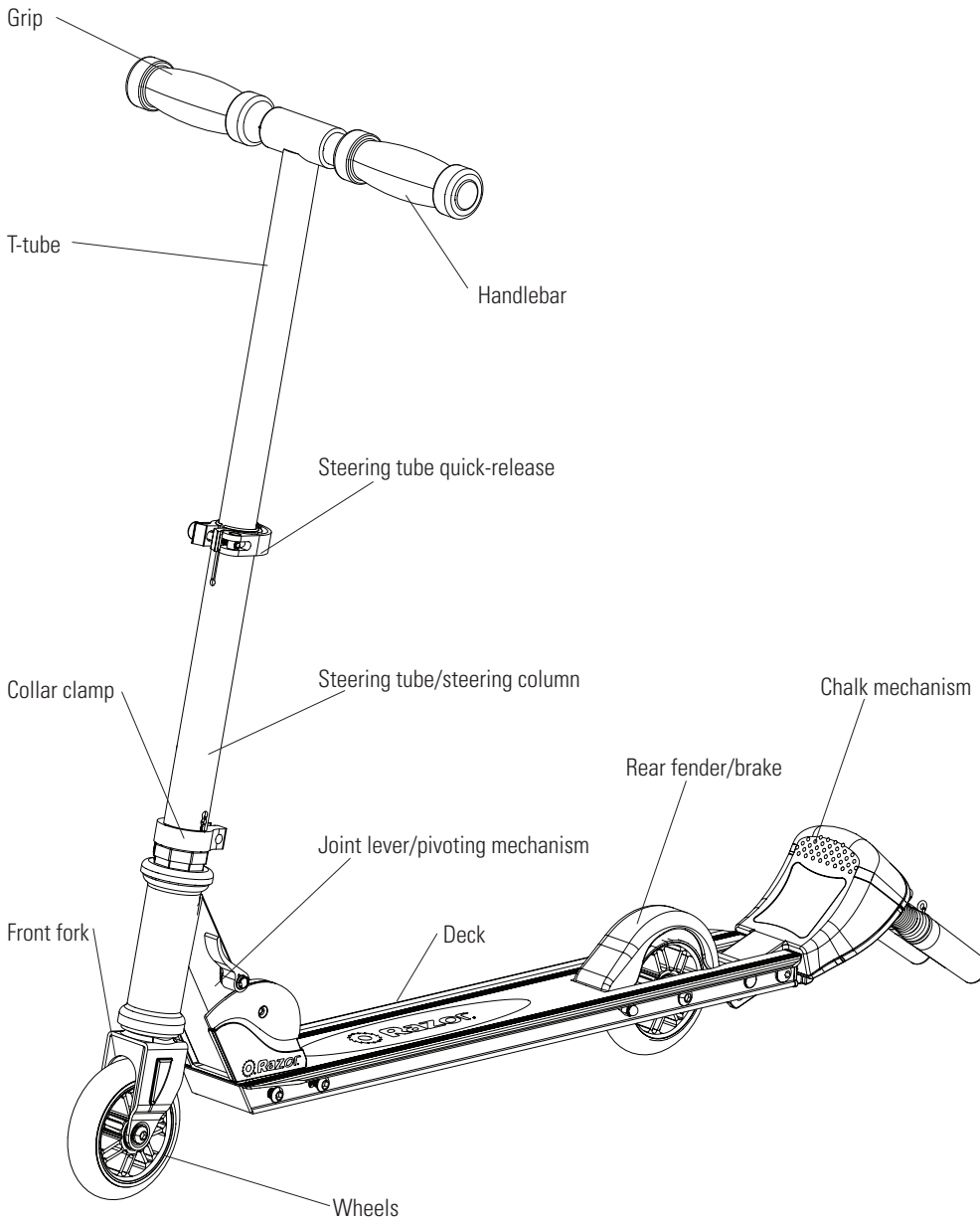

### Required Tools

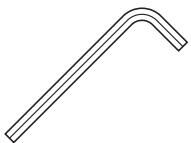

5mm  
Allen wrench  
(Not Included)

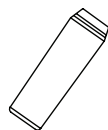

Chalk  
(Included)

**WARNING:** DO NOT USE NON-RAZOR PRODUCTS WITH YOUR SCOOTER.

Razor scooters have been built to certain Razor design specifications. The original equipment supplied at the time of sale was selected on the basis of its compatibility with the frame, fork and all other parts. Certain aftermarket products may or may not be compatible. Use of any non-Razor parts and/or modifications will void the warranty.

**Need Help?** Visit [www.razor.com](http://www.razor.com) for replacement parts, product support and a list of authorized service centers or call toll-free at 866-467-2967 Monday - Friday 8:00 AM - 5:00 PM Pacific Time.

# SET UP AND USAGE INSTRUCTIONS

## □ Unfolding the scooter for first time use.

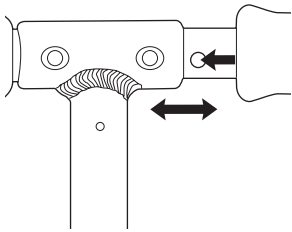

**1** Insert and secure the left and right handlebars by pressing the spring-loaded buttons and inserting them into the T-bar.

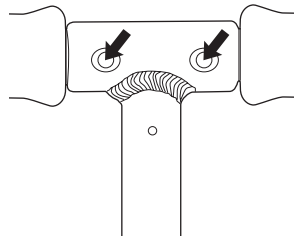

**2** Make certain **BOTH** handlebars are properly locked onto the T-bar.

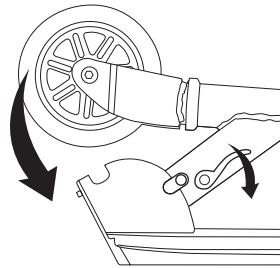

**3** To release the folding mechanism, put one foot on the deck plate and push joint release lever down. Raise handlebars up until securely locked in the upright position.

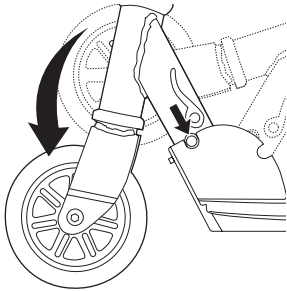

**Note:** The joint lever is spring-loaded and will automatically lock in the upright position when fully upright.

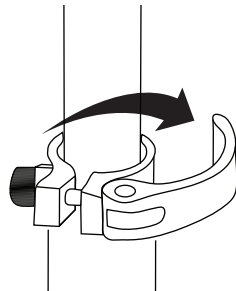

**4** To adjust the height of the handlebars, open the quick-release lever and slide the T-bar to the desired position and resecure the quick release lever to lock into place. If the T-bar is raised to the maximum height, depress the push button located directly below the quick release lever to lower the T-bar.

**⚠ WARNING:** Failure to properly engage the spring-loaded buttons may cause the handlebars to dislodge while riding and may cause you to lose control and fall. When correctly engaged the handlebars will not rotate nor will they move sideways. Note that when properly engaged, the spring-loaded buttons are clearly visible in the holes on the T-bar.

**⚠ WARNING:** Keep your fingers clear of the pivoting mechanism when folding or unfolding the scooter. Make sure others are standing clear.

**⚠ WARNING:** Failure to properly secure the quick-release lever may cause the T-bar to telescope up or down while riding which may cause you to lose control and fall.

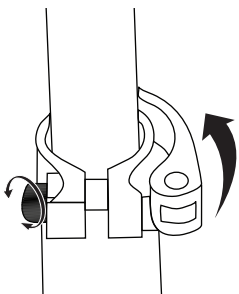

**Note:** The tension of the quick-release lever can be adjusted by tightening or loosening the Allen bolt. Be careful not to over-tighten. You should always be able to open and close the quick-release lever by hand and the T-bar should slide freely with the quick-release open.

# SET UP AND USAGE INSTRUCTIONS

## □ Installing your chalk

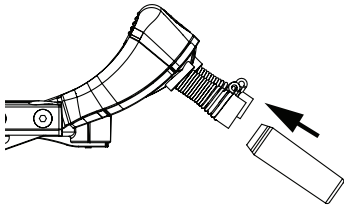

**1** Insert the tapered end of the chalk into the spring.

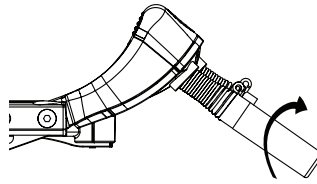

**2** Twist chalk clockwise 1/4 turn until chalk is set securely in the spring. Periodically turn chalk as needed.

## □ How to Ride

Place one foot on the baseboard, push forward with the other foot. Steer. For enhanced cornering, lean slightly into the direction of the turn. For controlled stops, apply the brake by stepping on the rear fender/brake. Razor recommends that you practice applying the brake at various speeds and in an open area free from obstructions before riding your Razor around others.

## □ Using the Chalk Bar

When riding, place ball of foot on the chalk bar and apply pressure until the chalking mechanism clicks into place. Only use enough pressure to cause chalk to make a mark. To stop chalking, place ball of foot on chalk bar and apply pressure until it clicks to the desired position.

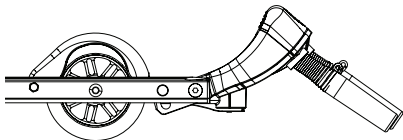

**1** Up Position - No chalking

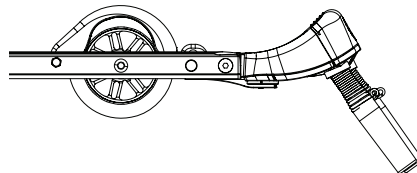

**2** Down Position - Chalking

**⚠ WARNING:** Keep fingers clear of chalk bar hinge and fender brake.

**NOTE:** Chalk is non-toxic. Conforms to ASTM4236. Chalk washes off with water for easy clean-up.

**⚠ WARNING:** Applying too much pressure on the chalk bar may cause loss of control.

**NOTE:** Using any other part of the foot or full foot may activate the brake and prevent the chalk action.

**NOTE:** Chalk marks and chalk life will vary based on the amount of pressure applied to the chalk bar and the smoothness of the riding surface.

**Need Help?** Visit [www.razor.com](http://www.razor.com) for replacement parts, product support and a list of authorized service centers or call toll-free at 866-467-2967 Monday - Friday 8:00 AM - 5:00 PM Pacific Time.

## CHECK BEFORE RIDING

### ❑ Collar Clamp

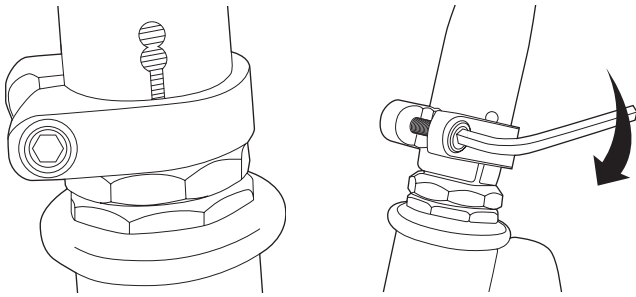

Using a 5mm Allen key, check that the collar clamp bolt is tightened securely. This part is tightened and quality inspected at the factory but there is a slight chance that the effects of shipping or handling may have caused this bolt to become loose.

### ❑ Wheels and Bearings

Under normal circumstances and conditions, Razor wheels and bearings are maintenance free. Nonetheless, it is the responsibility of the owner or guardian to periodically inspect the wheels for wear and tear, the axle for proper tightness, and bearings for side-to-side play and loose parts. When a wheel or wheel bearing develops play, this is an indication of excess wear and replacement is necessary. Replace immediately with only genuine Razor wheels. Wheels other than genuine Razor wheels may not be compatible with your Razor scooter. The use of anything other than genuine Razor replacement parts may affect your safety and will void your warranty.

### ❑ Cleaning Your Scooter

Wipe with a damp cloth to remove dirt and dust.

Do not use industrial cleaners or solvents as they may damage the surfaces. Do not use alcohol, alcohol-based or ammonia-based cleaners as they may damage or dissolve the plastic components or soften the decals or decal adhesive.

**⚠ WARNING:** Wheelies will break the chalk bar. Other stunt-type riding reduces your ability to maneuver and control the scooter. Take the necessary precautions, such as wearing appropriate protective gear and practice in a area safe for stunt riding and free from obstructions.

**NOTE:** Worn wheels, bearings and chalk cartridges are considered normal wear-and-tear and are not covered by the Razor Warranty.

# SCOOTER PARTS LIST

Keep your scooter running for years with genuine Razor parts. Visit our web site or e-mail us for more information on spare part availability. (Specifications subject to change without notice.)

- |                            |                         |
|----------------------------|-------------------------|
| 1. Foam Grips              | 12. 98mm Wheels         |
| 2. Handlebar               | 13. Coupling Axle Screw |
| 3. T-Bar                   | 14. Deck Insert (front) |
| 4. Quick-Release Lever     | 15. Reinforce Plate     |
| 5. Extension Tube          | 16. Joint Release Lever |
| 6. Collar Clamp            | 17. Folding Base        |
| 7. Headset                 | 18. Folding Protector   |
| 8. Head Tube               | 19. Fender/Brake        |
| 9. Fork                    | 20. Chalk Bar           |
| 10. Fork Protector         | 21. Deck Insert (rear)  |
| 11. Axle Bolt (front/rear) |                         |

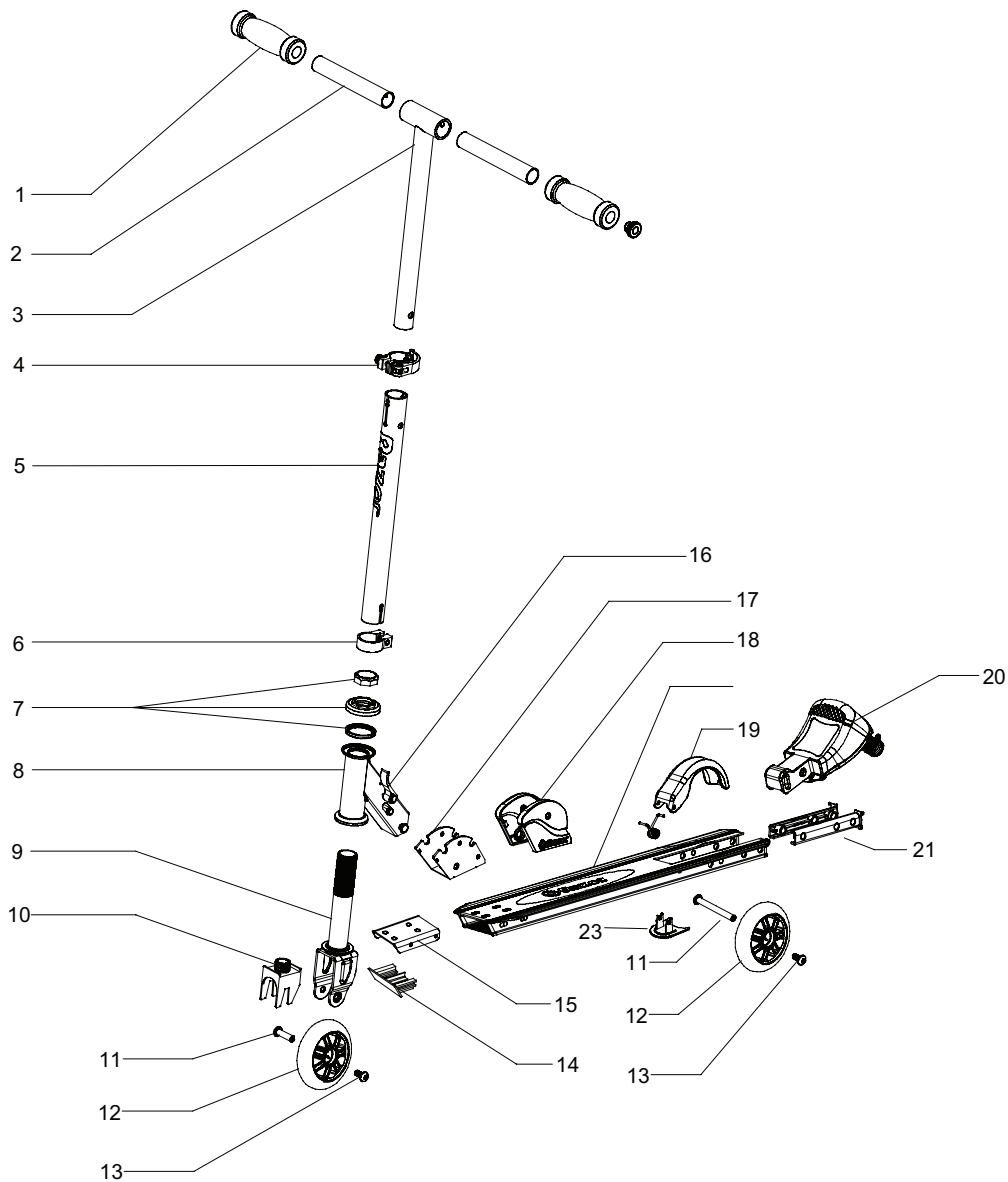

**Need Help?** Visit [www.razor.com](http://www.razor.com) for replacement parts, product support and a list of authorized service centers or call toll-free at 866-467-2967 Monday - Friday 8:00 AM - 5:00 PM Pacific Time.

## SAFETY REMINDERS

### PRE-RIDE CHECKLIST



#### Loose Parts

Check and secure all fasteners before every ride. Make sure the collar clamp, quick release lever, and handlebar spring buttons are locked properly in place before riding.



#### Replacement Parts

Replace worn or broken parts immediately. Call 1-866-GO-RAZOR for parts.



#### Safety Gear

Always wear proper protective equipment such as an approved safety helmet, elbow pads and kneepads. Always wear shoes (lace-up with rubber soles), never ride barefooted or in sandals, and keep shoelaces tied and out of the way of the wheels.



#### Be Careful!

You will see people on TV and maybe even people you know doing tricks and stunts. These are people who have been practicing on scooters for a very long time. Don't try something until you are ready. Avoid steep inclines and don't ride too fast — you can lose control and fall. Skateboard parks are not designed for scooters. Never ride in traffic or on the street and watch your surroundings for pedestrians, bikers, boarders and skaters.

Maintain a hold on the handlebars at all times.



**DO NOT RETURN TO STORE**  
Failure to follow these instructions may damage  
your product and void your warranty.

## WARRANTY

### Razor Limited Warranty

The manufacturer warrants this product to be free of manufacturing defects for a period of 6 months from date of purchase. This Limited Warranty does not cover normal wear and tear, or any damage, failure or loss caused by improper assembly, maintenance, or storage.

This Limited Warranty will be void if the product is ever

- used in a manner other than for recreation;
- modified in any way;
- rented.

The manufacturer is not liable for incidental or consequential loss or damage due directly or indirectly to the use of this product.

Razor does not offer an extended warranty. If you have purchased an extended warranty, it must be honored by the store at which it was purchased.

For your records, save your original sales receipt with this manual.

Item Number:

<b>Black</b>	<b>13010800</b>
<b>Blue</b>	<b>13010840</b>
<b>Purple</b>	<b>13010850</b>

**Need Help?** Visit [www.razor.com](http://www.razor.com) for replacement parts, product support and a list of authorized service centers or call toll-free at 866-467-2967 Monday - Friday 8:00 AM - 5:00 PM Pacific Time.

Printed in China for:  
Razor USA LLC  
PO Box 3610  
Cerritos, CA 90703

Copyright © 2003-2010 Razor USA, LLC. All rights reserved. RAZOR and the Razor Logo Design are among the registered trademarks of Razor USA LLC in the United States and/or select foreign countries. Graffiti is a trademark of Razor USA LLC.