



DIRT QUAD



OWNER'S MANUAL

⚠ Read and understand this entire manual BEFORE riding!

NOTE: Manual illustrations are for demonstration purposes only. Illustrations may not reflect exact appearance of actual product. Specifications subject to change without notice.

For assistance contact Razor. DO NOT RETURN TO STORE.

CONTENTS

Safety Warnings	1	Troubleshooting Guide	7-8
Before You Begin.....	2	Parts List.....	9-10
Assembly and Set-Up.....	3-4	Safety Reminders	12
Repair and Maintenance.....	4-6	Warranty Information.....	12

SAFETY WARNINGS

⚠ WARNING: Riding an electric four wheeler can be a hazardous activity. Certain conditions may cause the equipment to fail without fault of the manufacturer. Like other electric vehicles, the Dirt Quad can and is intended to move, and it is therefore possible to lose control, fall off and/or get into dangerous situations that no amount of care, instruction or expertise can eliminate. If such things occur you can be seriously injured or die, even when using safety equipment and other precautions. **RIDE AT YOUR OWN RISK AND USE COMMON SENSE.**

This manual contains many warnings and cautions concerning the consequences of failing to maintain, inspect or properly use your electric four wheeler. Because any incident can result in serious injury or even death, we do not repeat the warning of possible serious injury or death each time such a possibility is mentioned.

APPROPRIATE RIDER USE AND PARENTAL SUPERVISION

This manual contains important safety information. It is your responsibility to review this information and make sure that all riders understand all warnings, cautions, instructions and safety topics and assure that young riders are able to safely and responsibly use this product. Razor USA recommends that you periodically review and reinforce the information in this manual with younger riders, and that you inspect and maintain your children's vehicle to insure their safety.

The recommended rider age of 8 years is only an estimate, and can be affected by the rider's size, weight or skills. Any rider unable to fit comfortably on the Dirt Quad should not attempt to ride it.

A parent's decision to allow his or her child to ride this product should be based on the child's maturity, skill and ability to follow rules.

Keep this product away from small children and remember that this product is intended for use only by persons who are, at a minimum, completely comfortable and competent while operating the vehicle.

DO NOT EXCEED THE WEIGHT LIMIT OF 120 pounds. Rider weight does not necessarily mean a person's size is appropriate to fit or maintain control of the Dirt Quad.

Do not touch the brakes or electric motor on your electric four wheeler when in use as they can become very hot.

Refer to the following section on safety for additional warnings.

ACCEPTABLE RIDING PRACTICES AND CONDITIONS

Always check and obey any local laws or regulations which may affect the locations where the Dirt Quad may be used.

Ride defensively. Watch out for potential obstacles that could catch your wheel or force you to swerve suddenly or lose control. Be careful to avoid pedestrians, skaters, skateboards, scooters, bikes, children or animals who may enter your path, and respect the rights and property of others.

The Dirt Quad is meant to be used on private property and on closed courses and not on public streets or sidewalks. Do not ride your electric four wheeler in any areas where pedestrian or vehicle traffic is present.

Do not activate the speed control on the hand grip unless you are seated on the electric four wheeler and in a safe, outdoor environment suitable for riding.

This product was manufactured for performance and durability but are not impervious to damage. Jumping or other aggressive riding can

over-stress and damage any product, including the Dirt Quad, and the rider assumes all risks associated with high-stress activity.

Be careful and know your limitations. Risk of injury increases as the degree of riding difficulty increases. The rider assumes all risk associated with aggressive riding activities.

Maintain a hold on the handlebars at all times.

Never carry passengers or allow more than one person at a time to ride the electric four wheeler.

Never use near steps or swimming pools.

Keep your fingers and other body parts away from the drive chain, steering system, wheels and all other moving components.

Never use headphones or a cell phone when riding.

Never hitch a ride with another vehicle.

Do not ride the Dirt Quad in wet or icy weather and never immerse the electric four wheeler in water, as the electrical and drive components could be damaged by water or create other possibly unsafe conditions.

Wet, slick, bumpy, uneven or rough surfaces may increase risks of use. Do not drive the electric four wheeler in mud, ice, puddles or water. Avoid excessive speeds that can be associated with downhill rides. Never risk damaging surfaces such as carpet or flooring by use of an electric four wheeler indoors.

Do not ride at night or when visibility is limited.

PROPER RIDING ATTIRE

Always wear proper protective equipment such as an approved safety helmet (with chin strap securely buckled). A helmet may be legally required by local law or regulation in your area. Elbow pads and kneepads, a long-sleeved shirt, long pants and gloves are recommended. Always wear athletic shoes (lace-up shoes with rubber soles), never drive barefooted or in sandals, and keep shoelaces tied and out of the way of the wheels, motor and drive system.

USING THE CHARGER

The charger supplied with the electric four wheeler should be regularly examined for damage to the cord, plug, enclosure and other parts, and in the event of such damage, the batteries must not be charged until the charger has been repaired or replaced.

Use only with the recommended charger.

Use caution when charging.

The charger is not a toy. Charger should be operated by an adult.

Do not operate charger near flammable materials.

Unplug charger and disconnect from scooter when not in use.

Do not exceed charging time.

Always disconnect from the charger prior to wiping down and cleaning your scooter with liquid.

FAILURE TO USE COMMON SENSE AND HEED THE ABOVE WARNINGS INCREASES RISK OF SERIOUS INJURY. USE WITH APPROPRIATE CAUTION AND SERIOUS ATTENTION TO SAFE OPERATION.

BEFORE YOU BEGIN

Remove contents from box. Remove the foam separators that protect the components from damage during shipping. Inspect the contents of the box for scratches in the paint, dents or kinked cables that may have occurred during shipping. Because the Dirt Quad is 95 percent assembled and packed at the factory, there should not be any problems, even if the box has a few scars or dents.

Estimated Assembly and Set-Up Time

Razor recommends assembly by an adult with experience in bicycle mechanics. Allow up to 20 minutes for assembly, not including initial charge time. Allow up to 18 hours for initial charge (see page 3 for charging information).

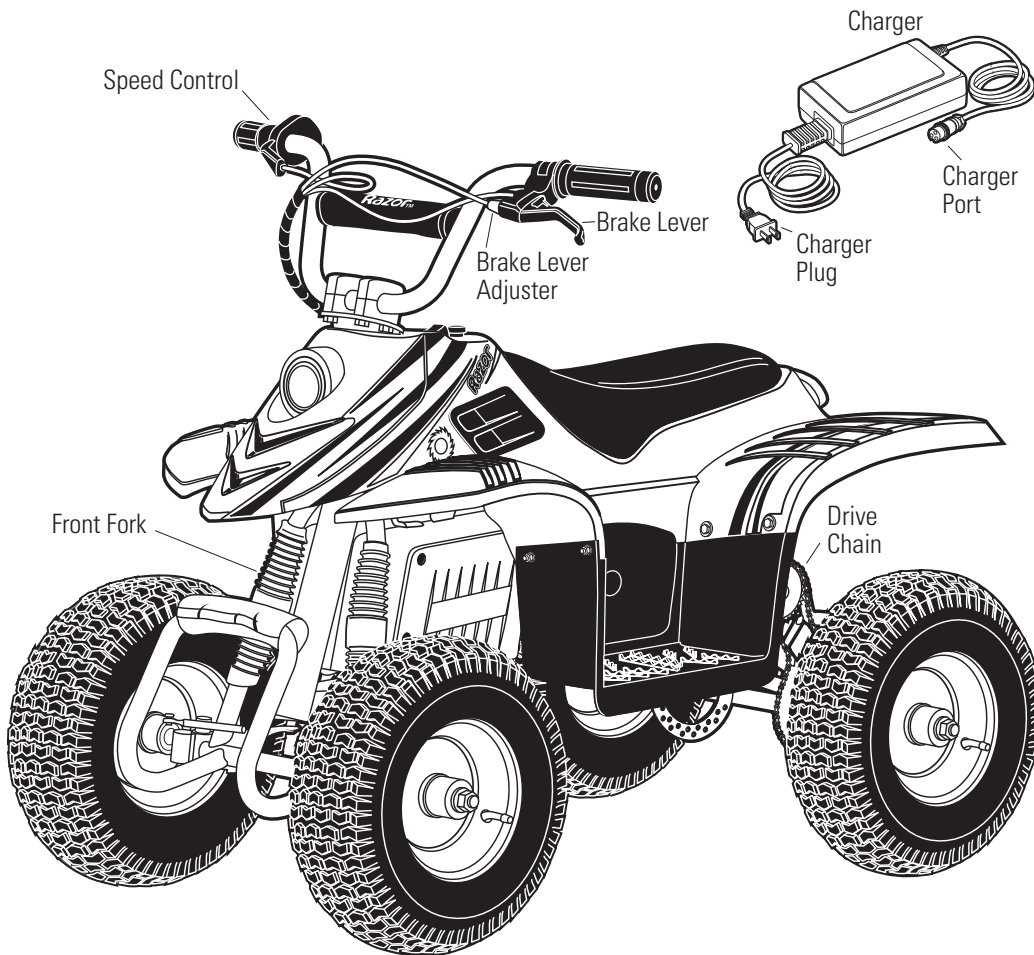

WARNING:
DO NOT USE NON-RAZOR PRODUCTS WITH YOUR RAZOR DIRT QUAD. The Dirt Quad has been built to certain Razor design specifications. The original equipment supplied at the time of sale was selected on the basis of its compatibility with the frame, fork and all other parts. Certain aftermarket products may or may not be compatible.

Bolt Assembly Torque Chart

ft-lb (Standard Metric 8.8 hardware for Razor Products)
The torque values in the table are based on the use of lubricated threads. Reduce 15% for dry threads.

Size (mm)	Torque in Ft-lb
6	5
7	9
8	17
10	33
12	60

Required Tools

Some tools may be supplied; however, we recommend the use of mechanic's grade tools. Use the supplied tools only as a last resort.

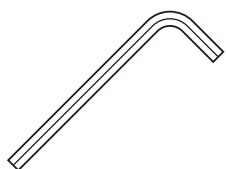

2.5mm, 5mm and 6mm hexagonal key wrenches (included)

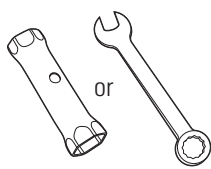

10mm wrench

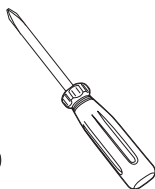

Phillips screwdriver

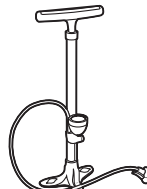

Bicycle-style tire pump for Schrader valve tires, with pressure gauge (not included)

N•m (Standard Metric 8.8 hardware for Razor Products)
The torque values in the table are based on the use of lubricated threads. Reduce 15% for dry threads.

Size (mm)	Torque in N•m
6	9
7	14
8	23
10	45
12	80

Need Help? Visit our web site for replacement parts, product support and a list of authorized service centers at www.razor.com or call toll-free at 866-467-2967 Monday - Friday 8:00 AM - 5:00 PM Pacific Time.

ASSEMBLY AND SET-UP

Charging the Battery

Your electric four wheeler may not have a fully charged battery; therefore it is a good idea to charge the battery prior to use.

- Initial charge time: 18 hours
 - Run time: up to 40 minutes
 - Average battery life: 250 charge/discharge cycles
- Recharge time: **Always** remember to turn the power switch off and recharge for at least 12 hours after each use. When vehicle is not in regular use, recharge battery at least once a month until normal use is resumed. If you have left the power switch on or your product has not been charged for a long period of time the battery may reach a stage at which it will no longer hold a charge.

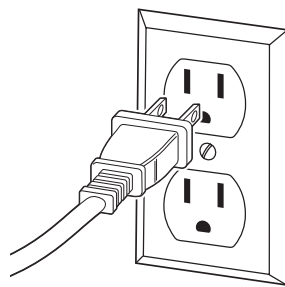
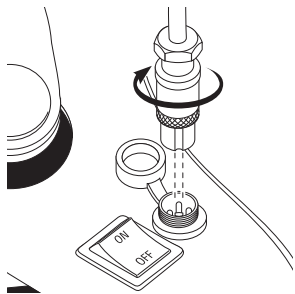
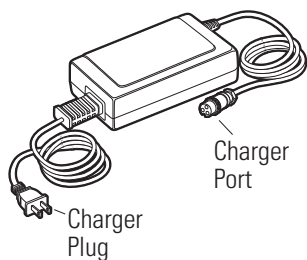

1 Plug the charger port into the port on the Dirt Quad. When charging, the power switch should be in the off position.

Be sure to properly align the groove on the charger input port with the corresponding socket on the Dirt Quad; otherwise, no charging action will occur.

2 Plug the charger plug into a wall outlet.

Attaching the Handlebars

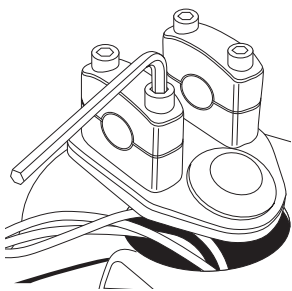

1 Using the 6mm hexagonal key wrench, remove bolts from handlebar clamp. **Handlebar clamps are located in the plastic bag.**

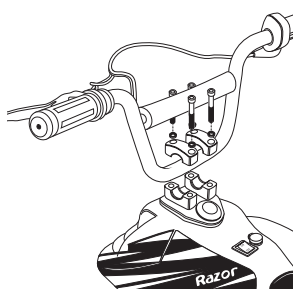

2 Place handlebars in handlebar clamp in upright, vertical position.

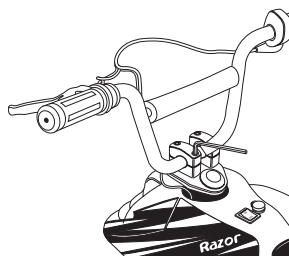

3 Insert bolts and tighten securely. When properly tightened, the handlebars should not move forward or back. **Note:** The gap between the upper clamp and lower clamp should be equal on both sides of handlebar.

! WARNING:

Always disconnect your electric four wheeler from the charger before cleaning with liquid.

Note: If your charger does not look like the one illustrated, your unit has been supplied with an alternative charger. The specifications and charging procedure would not change.

The charger has a small window with one LED or two LEDs to indicate the charge status. Refer to the illustration on the charger unit for the actual "charging" and "charged" status indications for your model charger.

Chargers have built-in over-charge protection to prevent battery from being over-charged.

! WARNING:

Failing to properly adjust and tighten the bolts that affix the handlebars can cause you to lose control and crash.

Need Help? Visit our web site for replacement parts, product support and a list of authorized service centers at www.razor.com or call toll-free at 866-467-2967 Monday - Friday 8:00 AM - 5:00 PM Pacific Time.

ASSEMBLY AND SET-UP

Inflating the Tires

Tires are inflated when shipped, but they invariably lose some pressure between the point of manufacturing and your purchase. **Always inflate the tires to the correct PSI before first time use.**

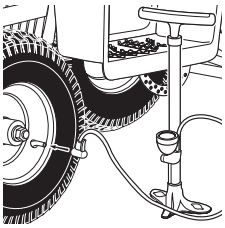

Using a bicycle-style tire pump equipped for a Schrader-type valve, inflate the front tire to the PSI indicated on the sidewall of the tire.

Testing the Brake

To use the brake, squeeze the lever to increase the pressure on the brake. The brake lever is fitted with a cable adjuster to compensate for cable stretch and/or to fine-tune the lever movement to brake engagement. If brake is not engaging properly, follow instructions for adjusting the brakes outlined below.

REPAIR AND MAINTENANCE

Turn power switch off before conducting any maintenance procedures.

□ Adjusting the Brake

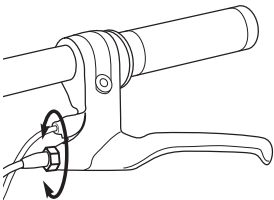

1 To adjust the play, thread the brake lever adjuster in or out 1/4 to 1/2 turn until the desired brake adjustment is attained. Most adjustments are complete at this step. If brake still needs further adjustment, proceed to step 2 for rear brake.

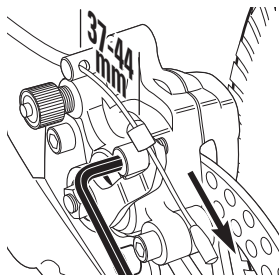

2 Locate the rear caliper brake and disc brake behind the right rear wheel. The distance of the brake wire between the end of the cable and the anchor bolt should be between 37 and 44 mm. If the rear brake has too much slack, loosen the rear anchor bolt with a hexagonal wrench and pull the brake wire tighter (direction indicated with arrow).

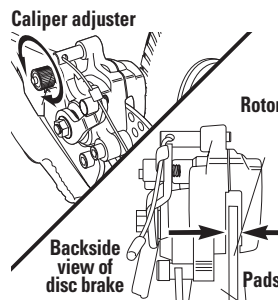

3 If the brake rotor is dragging on the brake pads use your fingers to twist the caliper adjuster in either direction until rotor is centered between pads.

Note: The pressurized air supplies found at gasoline stations are designed to inflate high-volume automobile tires. If you decide to use such an air supply to inflate your tires, first make sure the pressure gauge is working, then use very short bursts to inflate to the correct PSI. If you inadvertently over-inflate the tire, release the excess pressure immediately.

! WARNING:

The brake is capable of causing the electric four wheeler to skid the tires throwing an unsuspecting rider. Practice in an open area free from obstacles until you are familiar with the brake function. Avoid skidding to a stop as this can cause you to lose control or damage the rear tires.

Need Help? Visit our web site for replacement parts, product support and a list of authorized service centers at www.razor.com or call toll-free at 866-467-2967 Monday - Friday 8:00 AM - 5:00 PM Pacific Time.

REPAIR AND MAINTENANCE

□ Replacing the Fuse

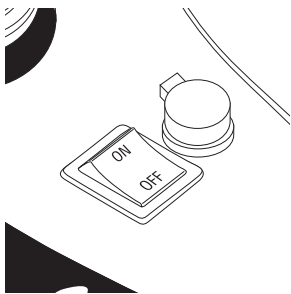

1 Make sure the power switch is turned off.

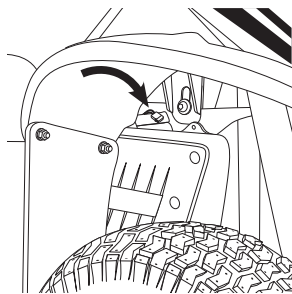

2 Under the front fender and through the frame, locate the fuse cover attached to the top of the battery.

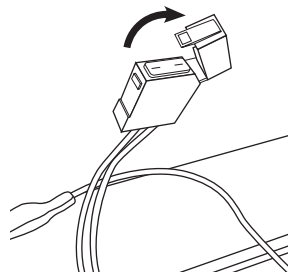

3 Open the fuse cover to expose the fuse.

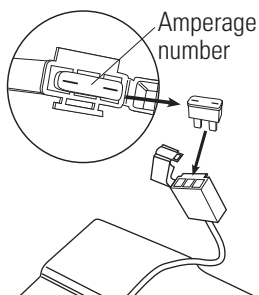

4 Remove the fuse and replace with a new one of equal amperage.

Note: Amperage rating is located on top of fuse.

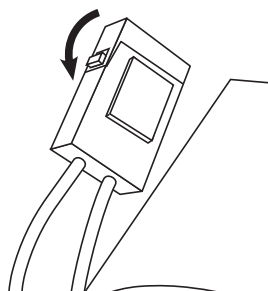

5 Close the fuse cover.

□ Replacing the Chain

Tools required: 5mm L-wrench, 6mm hexagonal key wrench, 10mm wrench and Phillips screwdriver.

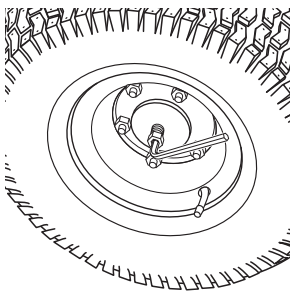

1 Remove the bolt on the outside of the rear wheel.

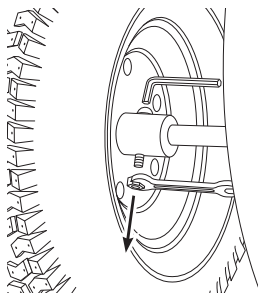

2 Remove the nut and bolt on the inside of the rear wheel. Pull bolt out of axle.

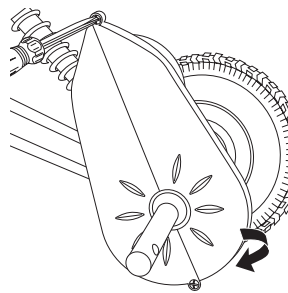

3 Remove the 3 screws from the top half of the chain guard and remove from frame.

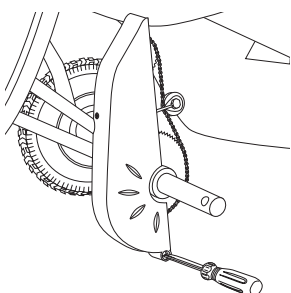

4 Remove the 2 screws from the bottom half of the chain guard and remove from frame.

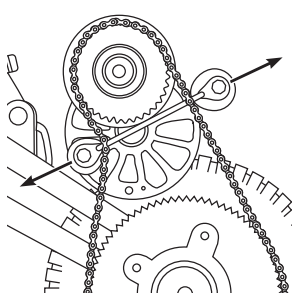

5 Spread the chain tensioner apart to loosen chain.

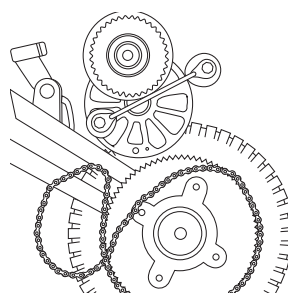

6 Remove chain from both sprockets and replace with new chain.

⚠ WARNING:

To prevent shock or short circuit, please follow the instructions accordingly and do not skip or combine any steps.

⚠ WARNING:

Do not touch motor after use. Motor is (or can be) very hot.

REPAIR AND MAINTENANCE

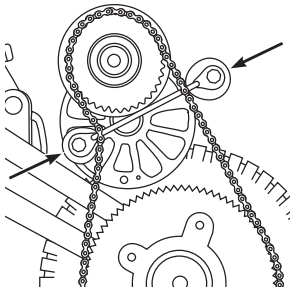

7 Reset chain tensioner.

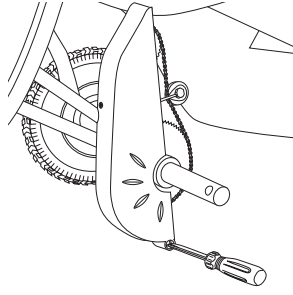

8 Position bottom half of the chain guard to align mounting holes and screw to frame.

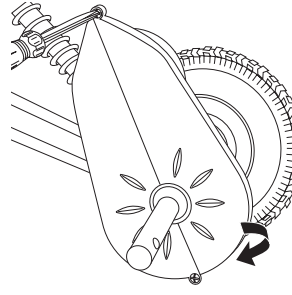

9 Position top half of the chain guard to align mounting holes and screw to frame.

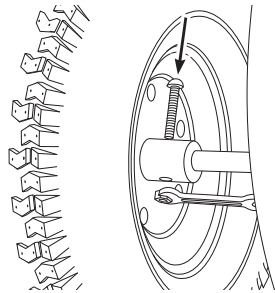

10 On the inside of the wheel slide bolt through wheel and axle and secure with nut.

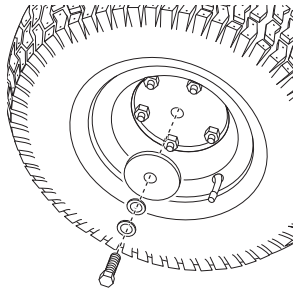

11 On the outside of the wheel replace washers and secure with bolt.

Chain and Sprocket

The chain will typically have a "loose spot" and "tight spot" corresponding with a particular sprocket rotational position. This is normal and common to all chain-driven vehicles due to run-out tolerances of the freewheel and sprocket. Proper chain alignment must be maintained. If the chain is noisy or rough running, check the lubrication, tension and alignment of the sprockets, in that order. The tensioner arms must be aligned and free from binding and the tensioner spring(s) must be operating correctly.

Battery Care and Disposal

Do not store the battery in temperatures above 75° F or below -10° F.



CONTAINS SEALED LEAD ACID BATTERIES. BATTERIES MUST BE RECYCLED.

Disposal: Your Razor product uses sealed lead-acid batteries which must be recycled or disposed of in an environmentally sound manner. Do not dispose of a lead-acid battery in a fire. The battery may explode or leak. Do not dispose of a lead-acid battery in your regular household trash. The incineration, land filling or mixing of sealed lead-acid batteries with household trash is prohibited by law in most areas. Return exhausted batteries to a federal or state approved lead-acid battery recycler or a local seller of automotive batteries. If you live in Florida or Minnesota, it is prohibited by law to throw away lead-acid batteries in the municipal waste stream.

Charger

The transformer/charger supplied with the bike should be regularly examined for damage to the cord, plug, enclosure and other parts, and, in the event of such damage, the Dirt Quad must not be charged until it has been repaired or replaced.

Use **ONLY** with the recommended charger.

Replacement Parts

The most frequently requested replacement parts (wheels, tires, tubes, batteries and chargers) are available for purchase at some Razor retail partners. For a complete selection of parts and accessories, visit our store at www.razor.com

Repair Centers

For a list of authorized Razor repair centers:

- Check online at www.razor.com.
- Call 866-467-2967 for the center nearest you.

WARNING:

To avoid a pinch or injury, keep fingers away from moving sprockets and chain.

WARNING:

If a battery leak develops, avoid contact with the leaking acid and place the damaged battery in a plastic bag. Refer to the disposal instructions at left. If acid comes into contact with skin or eyes, flush with cool water for at least 15 minutes and contact a physician.

WARNING:

Battery posts, terminals and related accessories contain lead and lead compounds. **Wash your hands after handling.**

TROUBLESHOOTING GUIDE

Problem	Possible Cause	Solution
Vehicle does not run.	Vehicle is rolling backwards.	Throttle will not engage if the vehicle is rolling backwards. Come to a complete stop and then activate the throttle.
	Undercharged battery.	Charge the battery. A new battery should have been charged for at least 18 hours before using the vehicle for the first time and up to 8 hours after each subsequent use. Check all connectors. Make sure the charger connector is tightly plugged into the charging port, and that the charger is plugged into the wall. Make sure power flow to the wall outlet is on.
	Charger is not working.	You may check to see if your charger is working by using a volt meter or asking your local Razor authorized service center to test your charger for you.
Vehicle was running but suddenly stopped.	Loose wires or connectors.	Check all wires and connectors to make sure they are tight.
	Burned-out fuse.	The fuse will burn out and automatically shut off the power if the motor is overloaded. An excessive overload, such as too heavy a rider or too steep a hill, could cause the motor to overheat. Refer to replacing the fuse instructions on page 5 of this manual. Correct the conditions that caused the fuse to burn out and avoid repeatedly burning out fuse.
	Motor or electrical switch damage.	Contact your local Razor authorized service center for diagnosis and repair.
Short run time (less than 30 minutes per charge).	Undercharged battery.	Charge the battery. A new battery should have been charged for at least 18 hours before using the vehicle for the first time and up to 12 hours after each subsequent use. Check all wires and connectors. Make sure the battery connector is tightly plugged into the charger connector, and that the charger is plugged into the wall. Make sure power flow to the wall outlet is on.
	Battery is old and will not accept full charge.	Even with proper care, a rechargeable battery does not last forever. Average battery life is 1 to 2 years depending on vehicle use and conditions. Replace only with a Razor replacement battery.
	Brakes are not adjusted properly	Refer to brake adjustment instructions on page 4 of this manual.
Vehicle runs sluggishly.	Driving conditions are too stressful.	Use only on solid, flat clean and dry surfaces such as pavement or level ground.
	Tires are not properly inflated.	The tires are inflated when shipped, but they invariably will lose some pressure between the point of manufacturing and your purchase. Refer to instructions on page 4 of this manual to properly inflate tires.
	Vehicle is overloaded.	Make sure you do not overload the vehicle by allowing more than one rider at one time, exceeding the maximum weight limit, going up too steep a hill or towing objects behind the vehicle.
Sometimes the vehicle doesn't run, but other times it does.	Loose wires or connectors.	Check all wires around the motors and all connectors to make sure they are tight.
	Motor or electrical switch damage.	Contact your local Razor authorized service center for diagnosis and repair.

Need Help? Visit our web site for replacement parts, product support and a list of authorized service centers at www.razor.com or call toll-free at 866-467-2967 Monday - Friday 8:00 AM - 5:00 PM Pacific Time.

TROUBLESHOOTING GUIDE

Problem	Possible Cause	Solution
Charger gets warm during use.	Normal response to charger use.	No action required. This is normal for some chargers and is no cause for concern. If your charger does not get warm during use, it does not mean that it is not working properly.
Vehicle does not stop when applying the brake.	Brakes are not adjusted properly.	Refer to instructions on page 4 of this manual to properly adjust brakes.
Vehicle makes loud noises or grinding sounds.	Chain is too dry.	Apply a lubricant such as 3 in 1™ or Tri-Flow™ to the chain.

Need Help? Visit our web site for replacement parts, product support and a list of authorized service centers at www.razor.com or call toll-free at 866-467-2967 Monday - Friday 8:00 AM - 5:00 PM Pacific Time.

DIRT QUAD PARTS

Keep your Dirt Quad running for years with genuine Razor parts. Visit our web site or e-mail us for more information on spare part availability. (Specifications subject to change without notice.)

01	Handlebar grip (right/left)	13	Chain tension assembly
02	Speed controller	14	Battery cover (left/right)
02-1	Sleeve	15	Rear wheel
03	Handlebar	16	Caliper brake
04	Brake lever assembly	17	Brake Disc
05	Handlebar clamp (upper/lower)	18	Chain
06	Shock	19	Sprocket
07	Front wheel	20	Chain guard (upper)
08	Spindle arm (left/right)	21	Chain guard (lower)
09	Adjustable tierod	22	Plastic body w/ seat
09-1	Non-adjustable tierod	22-1	On/ Off switch
10	Control module	22-2	Charger port w/ wires
11	Battery (2 - 12V/7Ah)	22-3	Footrest platform (left/right)
12	Motor (350W)		

Need Help? Visit our web site for replacement parts, product support and a list of authorized service centers at www.razor.com or call toll-free at 866-467-2967 Monday - Friday 8:00 AM - 5:00 PM Pacific Time.

DIRT QUAD PARTS

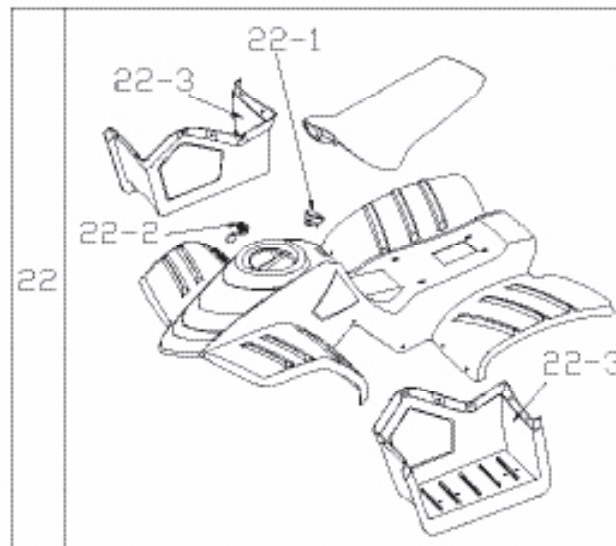
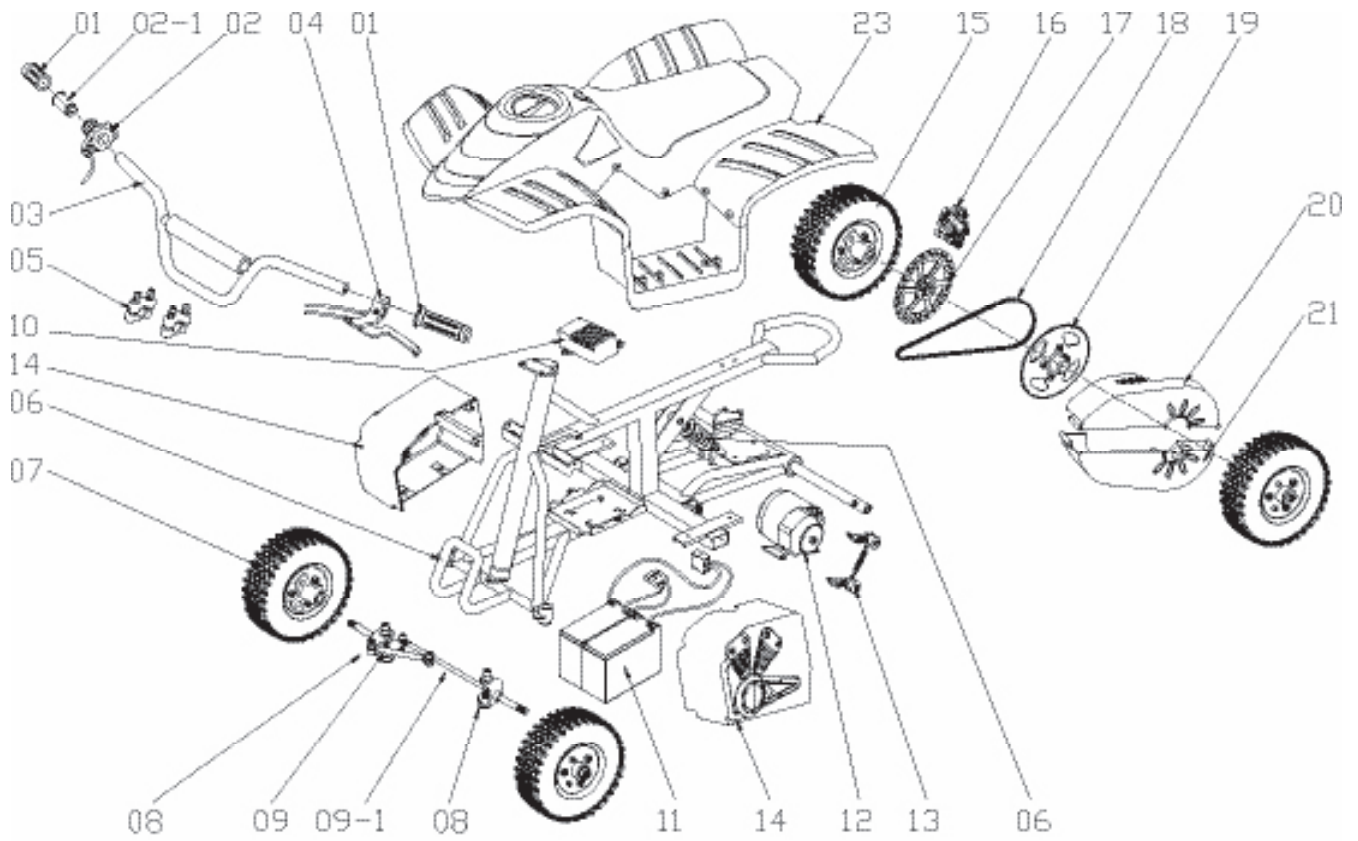

Need Help? Visit our web site for replacement parts, product support and a list of authorized service centers at www.razor.com or call toll-free at 866-467-2967 Monday - Friday 8:00 AM - 5:00 PM Pacific Time.

SB 1918 (CALIFORNIA) DECLARATION

YOUR INSURANCE POLICIES MAY NOT PROVIDE COVERAGE FOR ACCIDENTS INVOLVING THE USE OF THIS SCOOTER/ELECTRIC RIDE-ON PRODUCT. TO DETERMINE IF COVERAGE IS PROVIDED, YOU SHOULD CONTACT YOUR INSURANCE COMPANY OR AGENT.

SAFETY REMINDERS

PRE-RIDE CHECKLIST



Loose Parts

Check and secure all fasteners before every ride. Make sure steering stem clamp bolts are locked properly in place. There should not be any unusual rattles or sounds from loose parts or broken components. If you are not sure, ask an experienced mechanic to check.



Brake

Check the brake for proper function. When you squeeze the lever, the brake should provide positive braking action. When you apply the brake with the speed control on, the brake cut-off switch will stop the motor.



Frame, Fork and Handlebars

Check for cracks or broken connections. Although broken frames are rare, it is possible for an aggressive driver to bash into a curb or wall and wreck and bend or break a frame. Get in the habit of inspecting yours regularly.



Tire Inflation

Periodically inspect the tires for excess wear, and regularly check the tire pressure and re-inflate as necessary. If you get a flat tire, the inner tube can be patched or a new tube can be purchased from Razor or an authorized repair center.



Safety Gear

Always wear proper protective equipment such as an approved safety helmet, elbow pads and kneepads. Always wear shoes (lace-up shoes with rubber soles), never drive barefooted or in sandals, and keep shoelaces tied and out of the way of the wheels, motor and drive system.



DO NOT RETURN TO STORE

Do not use this vehicle for the first time until you have inflated the tires to the correct PSI and charged the battery for at least 12 hours.

Failure to follow these instructions may damage your vehicle and void your warranty.

WARRANTY

Razor Limited Warranty

The manufacturer warrants this product to be free of manufacturing defects for a period of 90 days from date of purchase. This Limited Warranty does not cover normal wear and tear, tires, tubes or cables, or any damage, failure or loss caused by improper assembly, maintenance, or storage or use of the Razor Dirt Quad.

This Limited Warranty will be void if the product is ever:

- used in a manner other than for recreation;
- modified in any way;
- rented.

The manufacturer is not liable for incidental or consequential loss or damage due directly or indirectly to the use of this product.

Razor does not offer an extended warranty. If you have purchased an extended warranty, it must be honored by the store at which it was purchased.

For your records, save your original sales receipt with this manual and write the serial number below.

Need Help? Visit our web site for replacement parts, product support and a list of authorized service centers at www.razor.com or call toll-free at 866-467-2967 Monday - Friday 8:00 AM - 5:00 PM Pacific Time.