



JETTS™ & JETTS™ DLX HEEL WHEELS



OWNER'S MANUAL

**Read and understand this entire manual before allowing child to use this product! For assistance contact Razor.
DO NOT RETURN TO STORE.**

**NOTE: Manual illustrations are for demonstration purposes only.
Illustrations may not reflect exact appearance of actual product.
Specifications subject to change without notice.**

Please have your product along with the 22 character product I.D. code with you before contacting Razor for warranty assistance and/or replacement parts.

Product I.D. Code: _____ - _____ - _____

CONTENTS

Safety Warnings	1-2	Repair and Maintenance.....	8
Before You Begin.....	3	Product Parts.....	9
Set-Up	4-5	Warranty	10
Pre-Ride Checklist.....	6	Contact Information	11
Usage	7		

SAFETY WARNINGS

⚠ AN IMPORTANT MESSAGE TO PARENTS:

This manual contains important information. For your child's safety, it is your responsibility to review this information with your child and make sure that your child understands all warnings, cautions, instructions and safety topics. All children and preteens should use with adult guidance at all times. Razor USA recommends that you periodically review and reinforce the information in this manual with younger users, and that you are required to inspect and maintain your child's heel wheels to ensure their safety.

⚠ GENERAL WARNING: Using heel wheels can be a hazardous activity. Heel wheels can, and are intended to move and it is therefore possible to get into dangerous situations and/or lose control and/or fall. If such things occur you can be seriously injured or die. **LIKE ANY OTHER MOVING PRODUCT, USING HEEL WHEELS CAN BE A DANGEROUS ACTIVITY AND MAY RESULT IN INJURY OR DEATH EVEN WHEN USED WITH PROPER SAFETY PRECAUTIONS. USE AT YOUR OWN RISK AND USE COMMON SENSE.**

- Always wear safety equipment, such as helmet, knee pads and elbow pads. Always wear a helmet when using your heel wheels and keep the chinstrap securely buckled.
- Always wear closed toe shoes.
- Avoid rolling faster than you can run.
- For outdoor use only on solid, clean, dry, hardened surfaces away from motor vehicles.
- Avoid sharp bumps, drainage grates, and sudden surface changes. Heel wheels may suddenly stop.
- Avoid streets and surfaces with water, sand, gravel, dirt, leaves, and other debris. Wet weather impairs traction and visibility.

- Do not use at night or in low visibility conditions.
- Avoid excessive speed associated with downhill use.
- Obey all local traffic and pedestrian laws and regulations.
- Watch out for pedestrians.
- Do not exceed 176 lb (80 kg) user weight.
- A parent's decision to allow his or her child to use this product should be based on the child's maturity, skill and ability to follow rules.
- Heel wheels are for use by children age 8+. Use under adult supervision at all times.
- User weight does not necessarily mean a child's size is appropriate to fit or maintain control of the heel wheels.

ACCEPTABLE RIDING PRACTICES AND CONDITIONS

Direct parental supervision is required. Heel wheels are meant to be used only in controlled environments free of potential traffic hazards and not on public streets. Do not allow your child to use heel wheels in any areas where vehicle traffic is present. Never use near steps, sloped driveways, hills, roadways, alleys or swimming pool areas.

Do not use heel wheels in wet weather. Heel wheels are intended for use on solid, flat, clean and dry surfaces, such as pavement or level ground without loose debris, such as rocks or gravel. Do not use heel wheels in mud, ice, puddles or water. Avoid excessive speeds that can be associated with downhill rides. Never risk damaging surfaces, such as carpet or flooring, by use of heel wheels indoors.

⚠ WARNING: SPARKS CAN INDUCE FIRE

SAFETY WARNINGS

To reduce the risk of **SERIOUS INJURY** or **FIRE**:

Razor recommends that the sparking capabilities of Jetts Heel Wheels be used only by riders aged 8+, who understand that risks may increase and riders should possess greater experience and maturity before using sparking toys.

PARENTS and **USERS**: Make sure users understand that sparks can start a fire. Keep sparks away from flammable or combustible substances. Use only under close adult supervision.

BE RESPONSIBLE: Safety is important. Parents must review the following warnings and instructions with each user:

- For outdoor use only on solid, clean, dry hardened surfaces. Keep sparks away from substances that can catch fire, such as dry vegetation, paper, chemicals or gasoline. Sparks can induce fire.
- Do not use in any area prone to wildfires or posted by fire authorities as a Fire Hazard Zone.
- Never use your Jetts Heel Wheels to try to start a fire. Your heel wheels emit localized sparks when the Spark Pads on moving heel wheels come in contact with hardened outdoor surfaces like asphalt or concrete. Be responsible.
- Do not use at night or in low visibility conditions.
- Keep sparks away from eyes, hair, exposed skin and clothing. Sparks can burn.
- Spark Pads get hot during use. Do not touch after use.
- Observe all other Jetts™ Heel Wheels safety warnings and instructions as provided elsewhere in this manual.
- Adults must assist children in replacing Spark Pads.

PROPER RIDING ATTIRE

Always ensure child is wearing proper protective equipment, such as an approved safety helmet.

FAILURE TO USE COMMON SENSE AND HEED THE ABOVE WARNINGS FURTHER INCREASES RISK OF SERIOUS INJURY. USE AT YOUR OWN RISK AND WITH APPROPRIATE AND SERIOUS ATTENTION TO SAFE OPERATION. USE CAUTION.

A helmet may be legally required by local law or regulation in your area. A child should always wear shoes and keep shoelaces tied and out of the way of the wheels. Never use while barefooted or in sandals. Knee pads and elbow pads are recommended.

⚠ WARNING: ALWAYS INSPECT HEEL WHEELS PRIOR TO RIDING. Properly inspecting and maintaining your heel wheels can reduce the risk of injury. Always inspect your heel wheels before using and regularly maintain them. Check and secure all fasteners before every use. Replace worn or broken parts immediately.

⚠ WARNING: CHECK LOCAL LAWS REGARDING USE. Check local laws and regulations to see where and how you may use your Razor heel wheels legally. In many states and local areas you may be required BY LAW to wear a helmet. Check local laws and regulations regarding laws governing helmet use in your area.

⚠ WARNING: Aggressive and other stunt-type riding reduces your ability to maneuver and control your heel wheels. Take the necessary precautions, such as wearing appropriate protective gear and practice in a safe area for stunt use and free from obstructions.

⚠ WARNING: You will see people on TV and videos or maybe even people you know doing tricks or stunts. These are people who have been practicing a long time and who accept the risks of trick activity. Do not assume that you can attempt to do the same tricks without great risk.

BEFORE YOU BEGIN

Remove contents from box. Inspect the contents of the box for scratches in the paint and/or dents that may have occurred during shipping. Because your heel wheels were assembled and packed at the factory, there should not be any problems, even if the box has a few scars or dents.

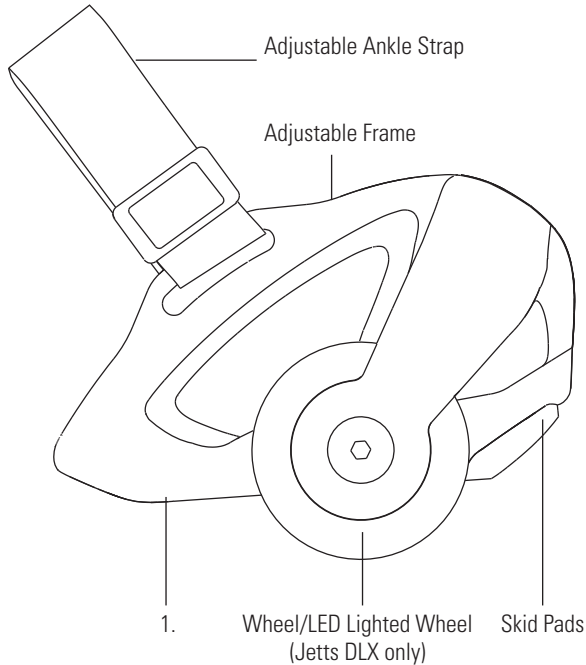

⚠ WARNING: DO NOT USE NON-RAZOR PRODUCTS WITH YOUR HEEL WHEELS. Razor heel wheels have been built to certain Razor design specifications. The original equipment supplied at the time of sale was selected on the basis of its compatibility with all parts. Certain aftermarket products may not be compatible and will void the warranty.

Product ID Locations: See locations to the left

1. Underneath Unit
2. Box - Side of UPC (Not Shown)

Box Contents:

- Heel Wheels
- Spark Pads
- Owner's Manual

Need Help? Visit our web site for replacement parts, product support, a list of authorized service centers in the US and customer service contact information at www.razor.com. Please have the product I.D. code (located on the white label of your product) available for better assistance. Additional Customer Service contact information is listed at the back of this manual.

SET-UP

□ Adjusting the Jetts

⚠ WARNING: Failure to properly adjust the Jetts may cause the user to lose control and fall.

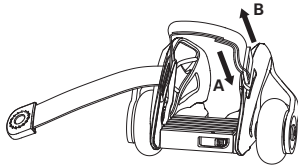

1 To make strap longer: Follow direction of the arrows to adjust. Pull the inner strap first (A), then the outer strap (B).

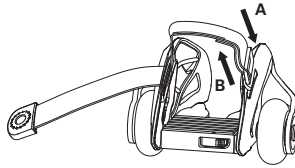

2 To make strap shorter: Follow direction of the arrows to adjust. Pull the outer strap first (A), then the inner strap (B).

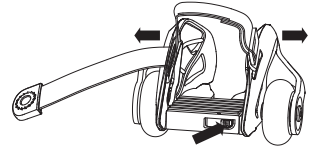

3 Press the button and pull the frame to its maximum width.



4 Follow the direction of the arrow to insert foot.

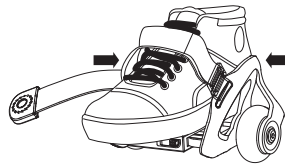

5 Place foot in heel wheel and push the frame from both sides until it clicks into place snugly fitting width of shoe.
Note: Adjustment must be done while wearing recommended appropriate footwear.

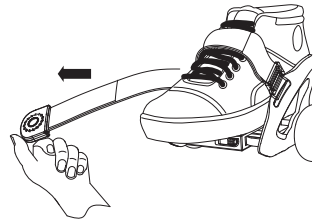

6 Follow direction of the arrow to tighten strap. Shoes must be snugly attached to the heel wheels before using.

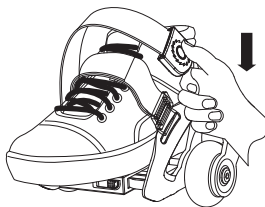

7 Pull tab down to secure the strap. Align and press together hook and pile sides of the strap. Make sure it is completely secure.

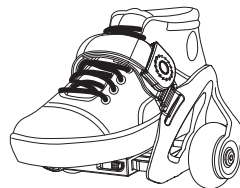

8 Make certain tab is on outside of shoe.

SET-UP

□ Installing/Replacing the Spark/Skid Pads

Friction during sparking will eventually wear out the replaceable Spark Pads and cause the Jetts to stop making sparks. Worn out Spark Pads should be replaced to avoid damaging the Jetts.

⚠ WARNING: Adults must assist children in replacing Spark Pads.

⚠ WARNING: Do not attempt to replace Spark Pads immediately after using as Spark Pads will be hot. Handle only when cool.

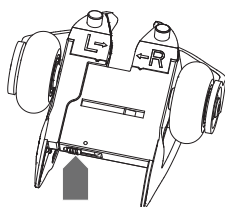

1 To remove spark or Skid Pads, press the button as shown and pull the frame to its maximum width.

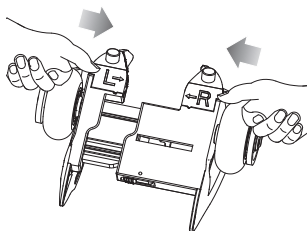

2 Push the right and left pads as shown.

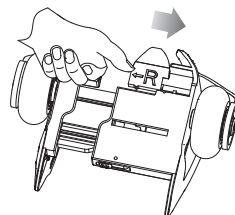

3 Push the replacement pads into the slot as shown.

Need Help? Visit our web site for replacement parts, product support, a list of authorized service centers in the US and customer service contact information at www.razor.com. Please have the product I.D. code (located on the white label of your product) available for better assistance. Additional Customer Service contact information is listed at the back of this manual.

PRE-RIDE CHECKLIST



Wheels

Impacting the wheels against any hard surface can damage the wheels. Wheels are not covered under your limited warranty.



Hardware/Loose Parts

Check and secure all fasteners before every ride. Make sure the strap is adhered properly in place before using. There should not be any unusual rattles or sounds from loose parts or broken components. If the unit is damaged, do not use. **Reference “Safety Warnings” on pages 1 and 2 of this manual.**



Safety Gear

Always wear proper protective gear, such as an approved safety helmet. Elbow pads and kneepads are recommended. Always wear closed toe shoes (lace-up with rubber soles) and keep shoelaces tied and out of the way of the wheels. **NEVER USE WHILE BAREFOOTED OR IN SANDALS.**



Laws and Regulations

Always check and obey any local laws or regulations.



Be Careful!

This product is not for aggressive or trick use. Avoid steep inclines and don't roll too fast — you can lose control and fall. Skate parks are not designed for young users. Never use in traffic or on the street and watch your surroundings for pedestrians, bikers, boarders and skaters.

USAGE

□ How to Ride

Stage 1- Practice:

- Find a fence, friend or something supportive to hold on to and maintain your balance.
- Position your feet:
 - One foot in front of the other (dominant foot in front position)
 - Knees slightly bent
 - Hands held out front
- Practice lifting your toes to feel the balance point of the wheels.

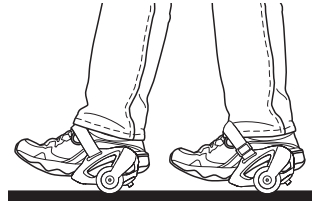

Stage 2- Give it a try:

- Starting with your back foot
- Step, set, then push off & roll (lift your toes)

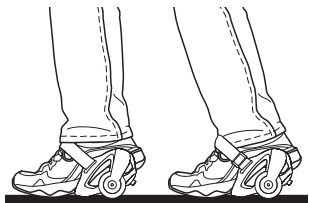

STEP

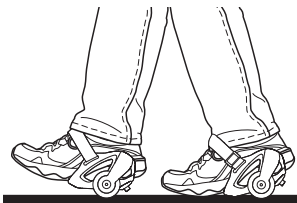

SET

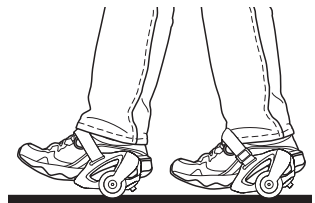

ROLL!

Stage 3 - On your own:

- When confident, try it without support.
- Keep your center of gravity over your heels. Do not lean backwards. It helps to keep your arms forward.

Sparking:

- Use your front foot.
- Lift your toes higher so that the Spark Pads come in contact with the surface.
- DO NOT attempt sparking until you have practiced rolling and are completely comfortable with the above steps.



Note:

- Lighted wheels light up when wheels are in motion (Jetts DLX only).

⚠ WARNING: Applying too much pressure on the Spark Pads may cause loss of control.

⚠ WARNING: Keep fingers clear of Spark Pads.

REPAIR AND MAINTENANCE

Cleaning

Wipe with a damp cloth to remove dirt and dust. Do not use industrial cleaners or solvents, as they may damage the surfaces. Do not use alcohol, alcohol-based or ammonia-based cleaners, as they may damage or dissolve the plastic components or soften the decals.

Wheels and Bearings

Under normal circumstances and conditions, Razor wheels and wheel bearings are maintenance free. Nonetheless, it is the responsibility of the owner or guardian to periodically inspect the wheels for wear and tear, the axle for proper tightness, bearings for side-to-side play, and for loose parts. When a wheel develops play, this is an indication of excess wear and replacement is necessary. Replace immediately with only genuine Razor wheels. Worn wheels/bearings are considered normal wear-and-tear and are not covered by the Razor Warranty. Wheels other than genuine Razor wheels may not be compatible with your Jetts Heel Wheels. The use of anything other than genuine Razor replacement parts may affect your safety and will void your warranty.

Replacement Parts

The most frequently requested replacement parts are available for purchase at some Razor retail partners. For the complete selection of replacement parts visit shop.razor.com.

Repair Centers

For a list of authorized Razor repair centers:

- Check online at www.razor.com.
- Additional Customer Service contact information is listed at the back of this manual.

Need Help? Visit our web site for replacement parts, product support, a list of authorized service centers in the US and customer service contact information at www.razor.com. Please have the product I.D. code (located on the white label of your product) available for better assistance. Additional Customer Service contact information is listed at the back of this manual.

PRODUCT PARTS

Keep your heel wheels rolling for years with genuine Razor parts. Visit our web site for more information on spare part availability. (Illustrations may not reflect exact appearance of actual product. Specifications subject to change without notice.)

1. Axle Bolt
2. Plastic Screw
3. Wheel/LED Lighted Wheel (Jetts DLX only)
 - 3-1 Bearing
 - 3-2 Spacer
4. Plastic Sleeve
5. Foot Strap
6. Skid Pad (Left/Right)
7. Spark Pad (Left/Right)

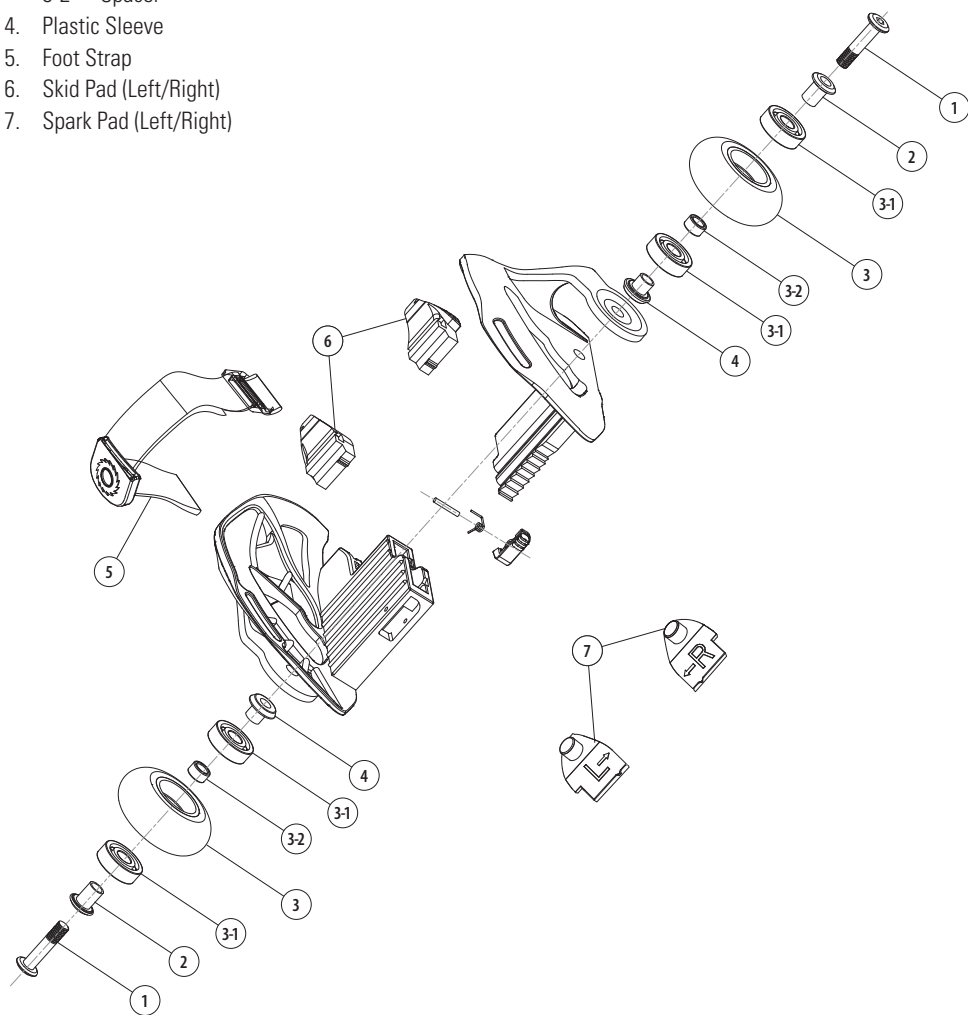

WARRANTY

Razor Limited Warranty

The manufacturer warrants this product to be free of manufacturing defects for a period of 6 months from date of purchase. This Limited Warranty does not cover normal wear and tear, or any damage, failure or loss caused by improper assembly, maintenance, or storage.

This Limited Warranty will be void if the product is ever:

- used in a manner other than for recreation or transportation;
- modified in any way;
- rented.

The manufacturer is not liable for incidental or consequential loss or damage due directly or indirectly to the use of this product.

Razor does not offer an extended warranty. If you have purchased an extended warranty, it must be honored by the store at which it was purchased.

For your records, save your original sales receipt with this manual and write the serial number below.

Need Help? Visit our web site for replacement parts, product support, a list of authorized service centers in the US and customer service contact information at www.razor.com. Please have the product I.D. code (located on the white label of your product) available for better assistance. Additional Customer Service contact information is listed at the back of this manual.

CUSTOMER SERVICE CONTACT INFORMATION

Need Help? Visit our web site for replacement parts, product support, a list of authorized service centers in the US and customer service contact information at www.razor.com. Please have the product I.D. code (located on the white label of your product) available for better assistance. Additional Customer Service contact information is listed below:

AMERICAS

Razor USA LLC
P.O. Box 3610
Cerritos, CA 90703
USA

+1 866 467 2967

Monday - Friday

8:00 AM - 5:00 PM Pacific Time

customersupport@razorusa.com

EUROPE

Razor USA LLC (Europe)
Handelsweg 2
2742 RD Waddinxveen
Netherlands

+44 (0) 1202 672702

ASIA

Razor USA LLC (Asia)
P.O. Box 3610
Cerritos, CA 90703
USA

+81 50 7579 6622

info@razor-asia.com

DISTRIBUTED IN THE UK BY:

Re:creation Limited
2 Meadows Business Park
Station Approach, Blackwater
Camberley, Surrey GU17 9AB
United Kingdom

+44 (0) 118 973 6222 *Tel*

+44 (0) 118 973 6220 *Fax*

sales@recreationltd.co.uk

DISTRIBUTED IN AUSTRALIA BY:

Funtastic Limited
Level 2, Tower 2, Chadstone Place
1341 Dandenong Road
Chadstone VIC 3148
Australia

+1 800 244 543

info@funtastic.com.au

Printed in China for Razor USA LLC.

Copyright © 2003-2016 Razor USA, LLC. All rights reserved. Razor® and the Razor logo design are among the registered trademarks of Razor USA LLC in the United States and/or select foreign countries. Jetts™ is a trademark of Razor USA LLC.

US_160721