



A5 AIR™ SCOOTERS



OWNER'S MANUAL

**Read and understand this entire manual before allowing child to use this product! For assistance contact Razor.
DO NOT RETURN TO STORE.**

**NOTE: Manual illustrations are for demonstration purposes only.
Illustrations may not reflect exact appearance of actual product.
Specifications subject to change without notice.**

Please have your product along with the 22 character product I.D. code with you before contacting Razor for warranty assistance and/or replacement parts.

Product I.D. Code: _____ - _____ - _____

CONTENTS

| | | | |
|--------------------------|-----|--|----|
| Safety Warnings | 1 | Usage | 6 |
| Before You Begin..... | 2 | Repair and Maintenance..... | 6 |
| Assembly and Set-up..... | 3-5 | Warranty and Contact Information | 10 |
| Pre-Ride Checklist..... | 6 | | |

SAFETY WARNINGS

⚠ AN IMPORTANT MESSAGE TO PARENTS: This manual contains important information. For your child's safety, it is your responsibility to review this information with your child and make sure that your child understands all warnings, cautions, instructions and safety topics. All children and preteens should ride with adult guidance at all times. Razor USA recommends that you periodically review and reinforce the information in this manual with younger riders, and that you inspect and maintain your child's scooter to ensure their safety.

⚠ GENERAL WARNING: Scooter riding can be a hazardous activity. Scooters can, and are intended to move and it is therefore possible to get into dangerous situations and/or lose control and/or fall. If such things occur you can be seriously injured or die. **LIKE ANY OTHER MOVING PRODUCT, USING A SCOOTER CAN BE A DANGEROUS ACTIVITY AND MAY RESULT IN INJURY OR DEATH EVEN WHEN USED WITH PROPER SAFETY PRECAUTIONS. USE AT YOUR OWN RISK AND USE COMMON SENSE.**

- Always wear safety equipment, such as helmet, knee pads and elbow pads. Always wear a helmet when riding your scooter and keep the chinstrap securely buckled.
- Always wear shoes.
- Ride on smooth, paved surfaces away from motor vehicles.
- Avoid sharp bumps, drainage grates, and sudden surface changes. Scooter may suddenly stop.
- Avoid streets and surfaces with water, sand, gravel, dirt, leaves, and other debris. Wet weather impairs traction, braking, and visibility.
- Do not ride at night.
- Brake will get hot from continuous use. Do not touch after braking.
- Avoid excessive speed associated with downhill rides.
- Adults must assist children in the initial assembly and/or adjustment procedures to fold/unfold scooter, and adjust handlebar and steering to height.
- Obey all local traffic and scootering laws and regulations.
- Watch out for pedestrians.
- Check and secure all fasteners before every ride.
- Replace worn or broken parts immediately.
- Always be sure to check tires for excessive wear or damage before riding.
- Do not exceed the tires PSI rating. Over inflation will cause a rupture.
- Do not exceed 220 lb (100 kg) total weight on the A5 Air scooter.
- A parent's decision to allow his or her child to ride this product should be based on the child's maturity, skill and ability to follow rules.
- Do not allow children under age eight (8) to use the scooter. All children and preteens should ride with adult supervision at all times.
- Rider weight does not necessarily mean a child's size is appropriate to fit or maintain control of the scooter.

ACCEPTABLE RIDING PRACTICES AND CONDITIONS

Direct parental supervision is required. Scooters are meant to be used only in controlled environments free of potential traffic hazards and not on public streets. Do not allow your child to ride a scooter in any areas where vehicle traffic is present. Child must maintain a hold on the handlebars at all times. Never allow more than one child at a time to ride a scooter. Never use near steps, sloped driveways, hills, roadways, alleys or swimming pool areas. Keep fingers and other body parts away from the product when folding or unfolding. Adults must not allow children to assist in assembling and/or folding or unfolding the scooter.

Do not ride a scooter in wet weather. Scooters are intended for use on solid, flat, clean and dry surfaces, such as pavement or level ground without loose debris, such as rocks or gravel. Wet, slick or uneven and rough surfaces may impair traction and contribute to possible accidents. Do not ride a scooter in mud, ice, puddles or water. Avoid excessive speeds that can be associated with downhill rides. Never risk damaging surfaces, such as carpet or flooring, by use of a scooter indoors. Do not ride at night or when visibility is impaired.

PROPER RIDING ATTIRE

Always ensure child is wearing proper protective equipment, such as an approved safety helmet. A helmet may be legally required by local law or regulation in your area. A child should always wear shoes and keep shoelaces tied and out of the way of the wheels. Never ride barefooted or in sandals. Knee pads and elbow pads are recommended.

⚠ WARNING: ALWAYS INSPECT SCOOTER PRIOR TO RIDING. Properly inspecting and maintaining your scooter can reduce the risk of injury. Always inspect your scooter before riding and regularly maintain it. Check and secure all fasteners before every ride. Replace worn or broken parts immediately.

⚠ WARNING: CHECK LOCAL LAWS REGARDING SCOOTER USE. Check local laws and regulations to see where and how you may use your Razor scooter legally. In many states and local areas scooter riders are required BY LAW to wear a helmet. Check local laws and regulations regarding laws governing helmet use and scooter operation in your area.

FAILURE TO USE COMMON SENSE AND HEED THE ABOVE WARNINGS FURTHER INCREASES RISK OF SERIOUS INJURY. USE AT YOUR OWN RISK AND WITH APPROPRIATE AND SERIOUS ATTENTION TO SAFE OPERATION. USE CAUTION.

Need Help? Visit our web site for replacement parts, product support, a list of authorized service centers in the US and customer service contact information at www.razor.com. Please have the product I.D. code (located on the white label of your product) available for better assistance. Additional Customer Service contact information is listed at the back of this manual.

BEFORE YOU BEGIN

Remove contents from box. Remove the separators that protect the components from damage during shipping. Inspect the contents of the box for scratches in the paint, dents that may have occurred during shipping. Because your scooter was assembled and packed at the factory, there should not be any problems, even if the box has a few scars or dents.

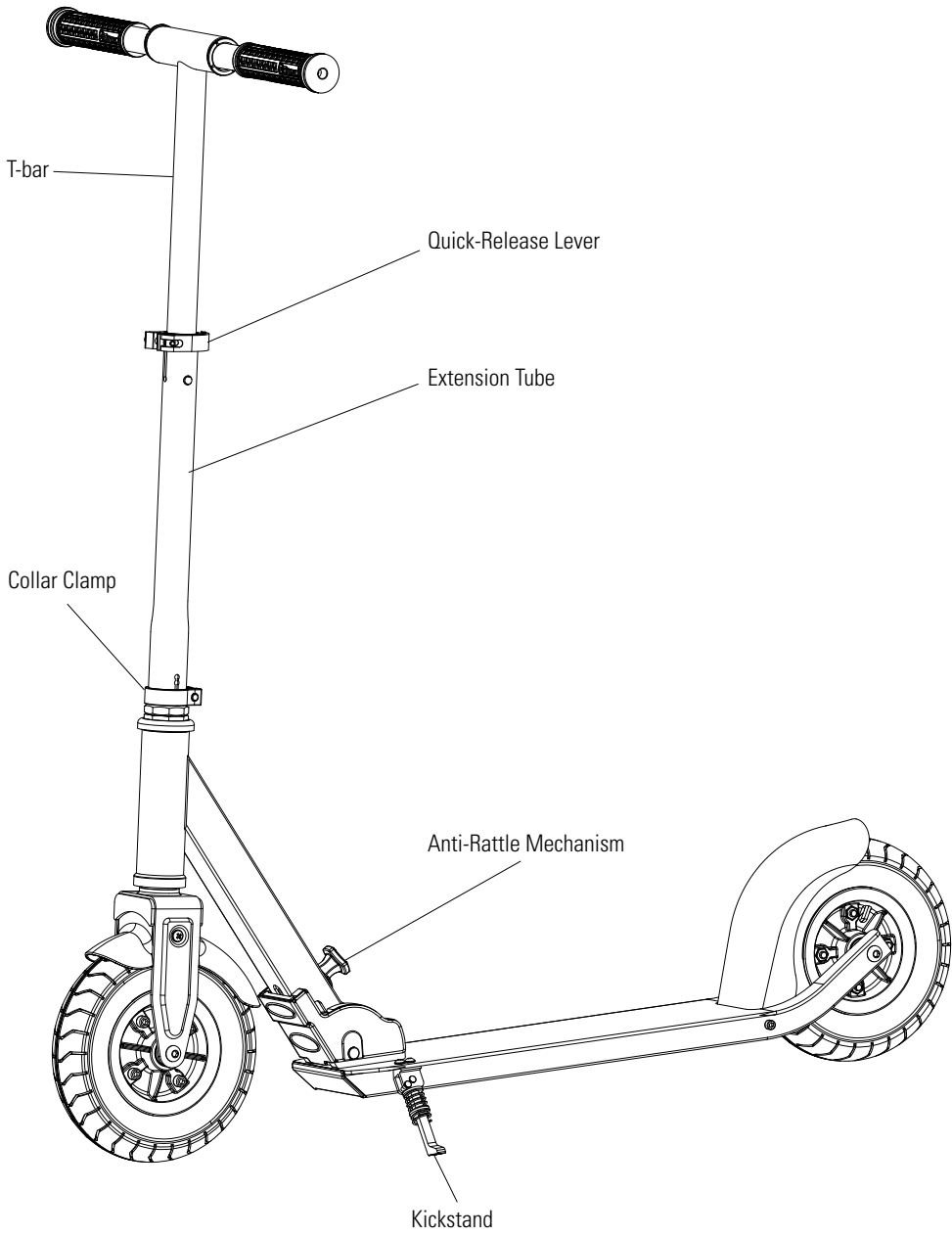

□ Required Tools

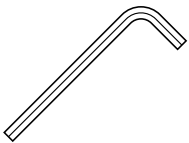

5 mm Allen wrench

⚠ WARNING: DO NOT USE NON-RAZOR PRODUCTS WITH YOUR SCOOTER.

Razor scooters have been built to certain Razor design specifications. The original equipment supplied at the time of sale was selected on the basis of its compatibility with the frame, fork and all other parts. Certain aftermarket products may not be compatible and will void the warranty.

Product ID Locations:

1. Side of Deck Plate
2. Box - side of UPC (not shown)

Box Contents:

- Scooter
- Allen Wrench
- Owner's manual

Need Help? Visit our web site for replacement parts, product support, a list of authorized service centers in the US and customer service contact information at www.razor.com. Please have the product I.D. code (located on the white label of your product) available for better assistance. Additional Customer Service contact information is listed at the back of this manual.

ASSEMBLY AND SET-UP

□ Unfolding the Scooter for First Time Use

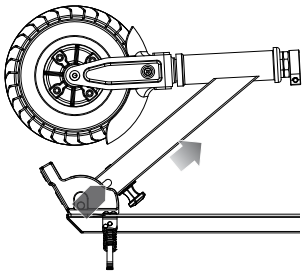

1 To release the folding mechanism, place the scooter on the ground, put one foot on the deck plate and pull the Anti-Rattle knob up. Raise T-bar up until it is securely locked in the upright position.

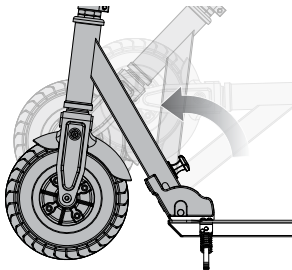

Note: The Anti-Rattle knob is spring-loaded and will automatically lock in the upright position when fully upright.

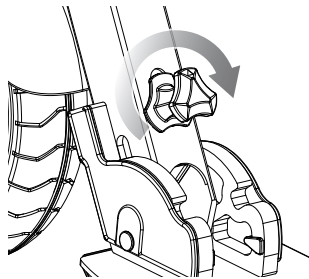

Note: To activate the anti-rattle feature twist the knob to the right to tighten. Please note there is no need to over tighten.

⚠ WARNING: Keep fingers clear of the pivoting mechanism when folding or unfolding the scooter. Make sure others are standing clear.

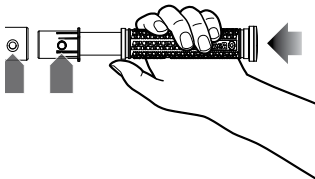

2 Insert and secure the left and right handlebars by pressing the spring-loaded buttons and inserting them into the T-bar.

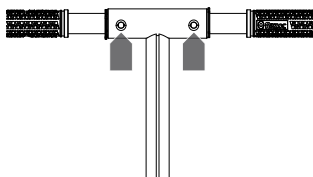

3 Make certain **BOTH** handlebars are properly locked onto the T-bar.

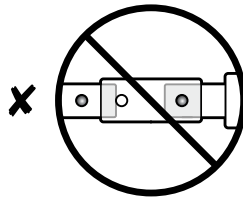
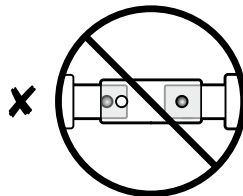

⚠ WARNING: Failure to properly engage the spring-loaded buttons may cause the handlebars to dislodge while riding and may cause you to lose control and fall. When correctly engaged the handlebars will not rotate nor will they move sideways. Note that when properly engaged, the spring-loaded buttons are clearly visible in the holes on the T-bar.

□ Adjusting the Handlebar Height

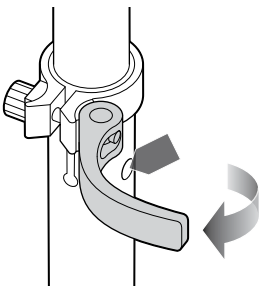

1 To adjust the height of the handlebars, open the quick-release lever and slide the T-bar to the desired position and resecure the quick release lever to lock into place. When the T-bar is raised to the maximum height, depress the push button located directly below the quick release lever to unlock the T-bar.

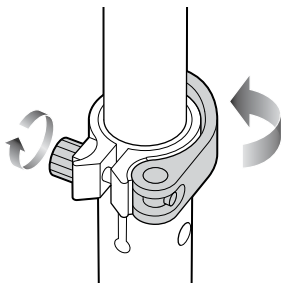

Note: The tension of the quick-release lever can be adjusted by manually tightening or loosening the Allen bolt. Be careful not to over-tighten. You should always be able to open and close the quick-release lever by hand and the T-bar should slide freely when the quick-release is open.

⚠ WARNING: Failure to properly secure the quick-release lever may cause the T-bar to telescope up or down while riding and may cause you to lose control and fall.

ASSEMBLY AND SET-UP

Collar Clamp

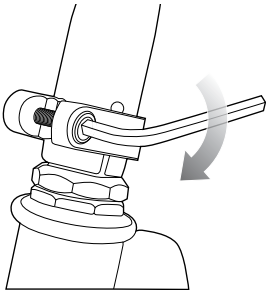
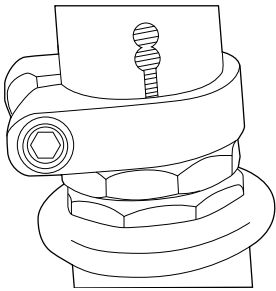

Using a 5 mm Allen wrench, check that the collar clamp bolt is tightened securely. This item is tightened and quality inspected at the factory, but there is a slight chance that the effects of shipping or handling may have caused the bolt to loosen.

⚠ WARNING: Failure to properly install and tighten the collar clamp may cause the rider to lose control and fall. If you are having difficulty understanding these instructions, please contact Razor Customer Service for assistance.

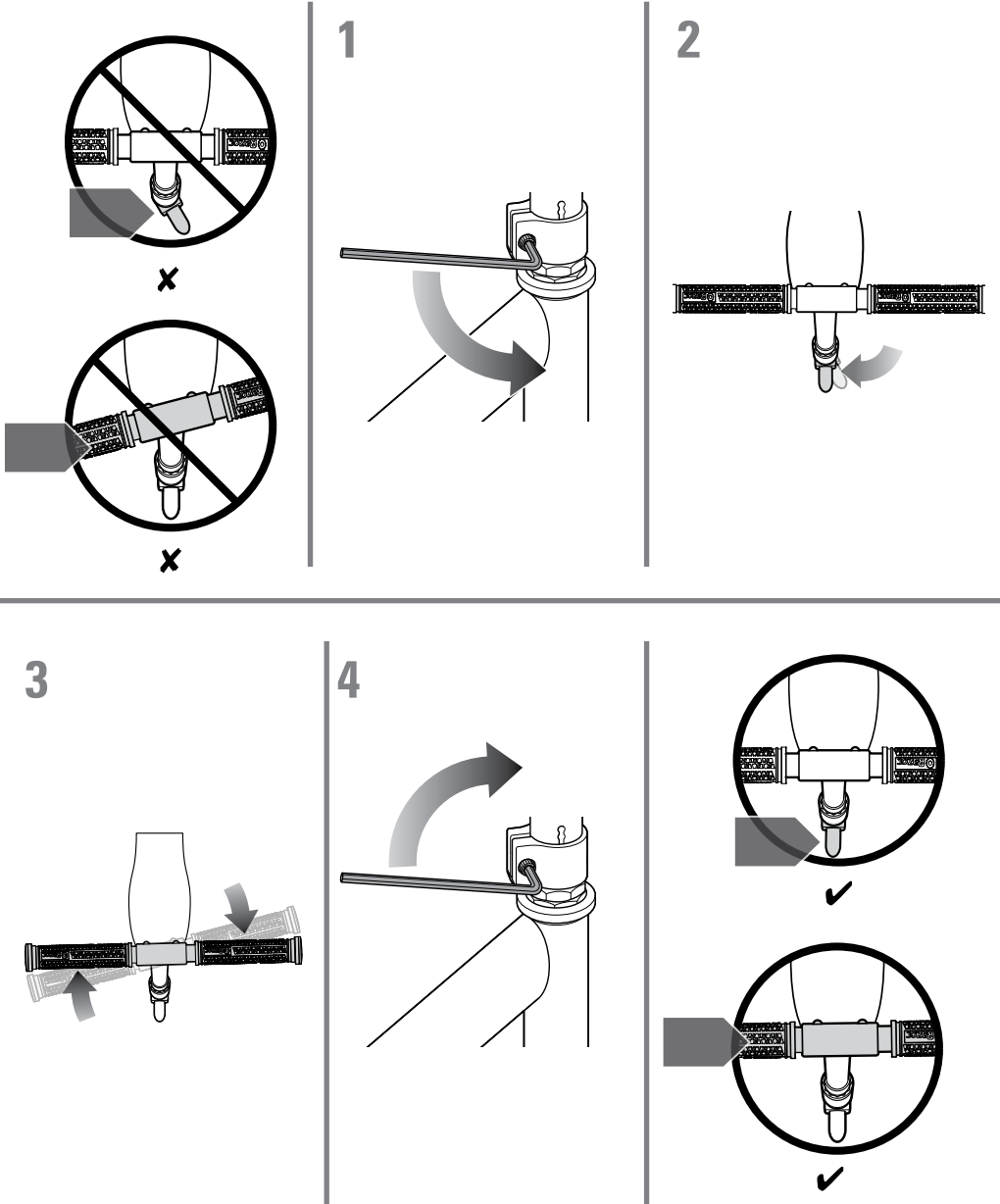

ASSEMBLY AND SET-UP

□ Inflating the Tire

The tires are inflated when shipped, but they invariably may lose some pressure between the point of manufacturing and your purchase. **Always inflate tire to the correct PSI before first time use.**

Periodically check both tires. Reinflate when needed.

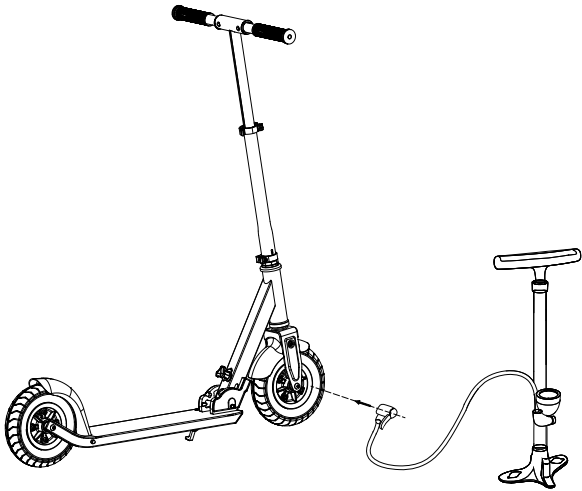

1 Using a bicycle-style tire pump equipped for a Schrader-type valve, inflate the tires to the correct PSI indicated on the sidewall of the tires.

⚠ WARNING: Inflate the tires to the recommended pressure (60 PSI) before riding. Do not exceed the tires' PSI rating. Over inflation will cause a rupture and under inflation may cause additional wear on the tire.

□ Anti-rattle Folding Mechanism

To fold scooter you must first deactivate the anti-rattle feature. Twist the knob to the left until loose. No need to loosen the knob more than one full turn. Pull the Anti-Rattle knob up to fold.

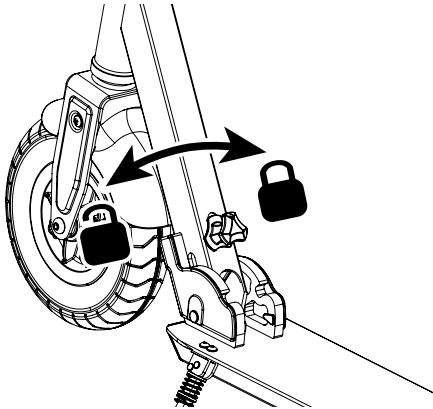

Need Help? Visit our web site for replacement parts, product support, a list of authorized service centers in the US and customer service contact information at www.razor.com. Please have the product I.D. code (located on the white label of your product) available for better assistance. Additional Customer Service contact information is listed at the back of this manual.

PRE-RIDE CHECKLIST



Loose Parts/Tire Care

Check and secure all fasteners before every ride. Make sure the collar clamp is locked properly in place before riding. Inspect tires for signs of wear or damage. Measure and adjust the PSI of the tires accordingly. Do not exceed 60 PSI.



Replacement Parts

Replace worn or broken parts immediately. Call 1-866-467-2967 for parts or visit www.razor.com.



Safety Gear

Always wear proper protective equipment, such as an approved safety helmet, elbow pads and kneepads. Always wear shoes (lace-up with rubber soles) and keep shoelaces tied and out of the way of the wheels. Never ride barefooted or in sandals.



Be Careful!

You will see people on TV and maybe even people you know doing tricks and stunts. These are people who have been practicing on scooters for a very long time. Don't try something until you are ready. Avoid steep inclines and don't ride too fast — you can lose control and fall. Skateboard parks are not designed for scooters. Never ride in traffic or on the street and watch your surroundings for pedestrians, bikers, boarders and skaters.

Maintain a hold on the handlebars at all times.

USAGE

How to Ride

Place one foot on the baseboard, push forward with the other foot. Steer with both hands on the handlebars. For enhanced cornering, lean slightly into the direction of the turn. For controlled stops, apply the brake by stepping on the rear brake. Razor recommends that you practice applying the brake at various speeds and in an open area free from obstructions before riding your scooter around others.

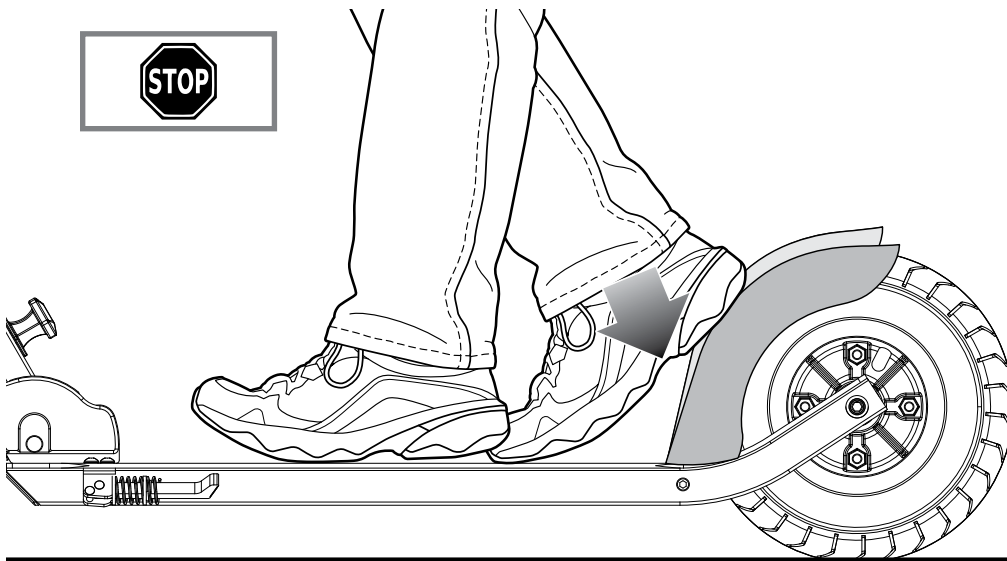

REPAIR AND MAINTENANCE

❑ Collar Clamp

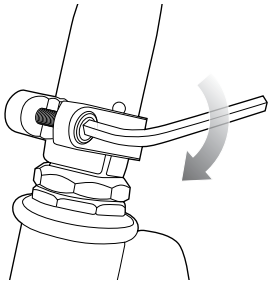

❑ Tires

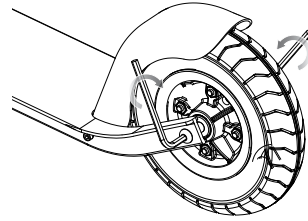
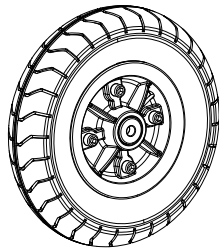

Using a 5mm Allen wrench, check that the clamp bolts are tightened securely. Check the pressure of your tires and inspect them for any signs of damage. Check your front and rear bolts to ensure they are tight.

❑ Cleaning Your Scooter

Wipe with a damp cloth to remove dirt and dust. Do not use industrial cleaners or solvents as they may damage the surfaces. Do not use alcohol, alcohol-based or ammonia-based cleaners as they may damage or dissolve the plastic components or soften the decals or decal adhesive.

❑ Wheels and Bearings

It is the responsibility of the owner or guardian to periodically inspect the wheels for wear and tear, the axle for proper tightness, and bearings for side-to-side play and loose parts. When a wheel or wheel bearing develops play, this is an indication of excess wear and replacement is necessary. Replace immediately with only genuine Razor replacement wheels. Worn wheels/bearings are considered normal wear and tear and are not covered by the Warranty. Other manufacturers' wheels may not be compatible with your A5 Air scooter, may affect your safety and will void your warranty.

❑ Replacement Parts

The most frequently requested replacement parts are available for purchase at some Razor retail partners. For the complete selection of replacement parts visit shop.razor.com.

❑ Repair Centers

For a list of authorized Razor repair centers:

- Check online at www.razor.com.
- Additional Customer Service contact information is listed at the back of this manual.

⚠ WARNING: Wheelies and other stunt-type riding reduces your ability to maneuver and control your scooter. Take the necessary precautions, such as wearing appropriate protective gear and practice in a area safe for stunt riding and free from obstructions.

Need Help? Visit our web site for replacement parts, product support, a list of authorized service centers in the US and customer service contact information at www.razor.com. Please have the product I.D. code (located on the white label of your product) available for better assistance. Additional Customer Service contact information is listed at the back of this manual.

REPAIR AND MAINTENANCE

❑ Replacing the Tires/Tubes

Tools Required: 5 mm Allen Wrench

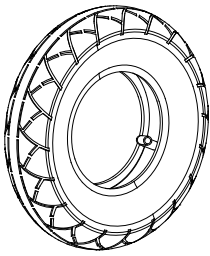

1 Completely deflate the tire. Use a 5mm Allen wrench to remove the four bolts on the hub. Remove the worn/damaged tire or inner tube and replace it with a new one.

Note: Be careful not to lose the four nuts on the opposite side of the hub.

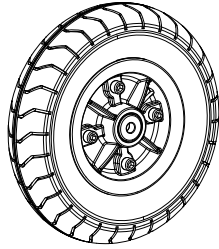

2 Assemble the hub using the diagram at right. Tighten bolts using 5mm Allen wrench. Re-inflate. (Do not exceed 60 PSI)

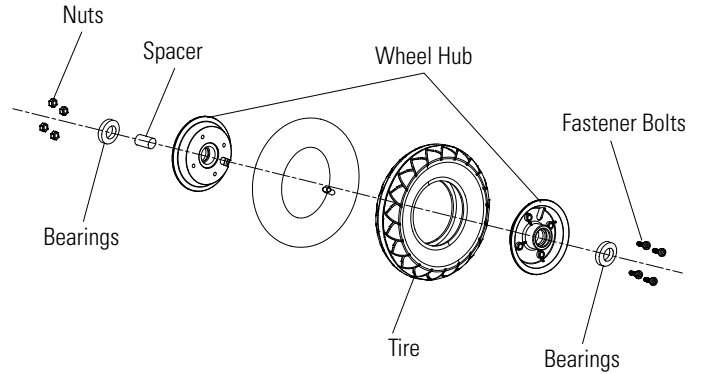

❑ Replacing the Wheels

Tools Required: 5 mm Allen Wrench

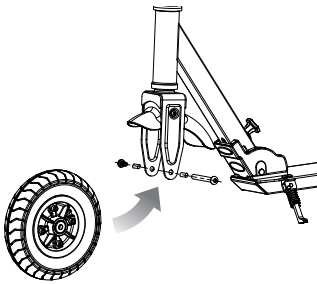

1 Front wheel sequence.

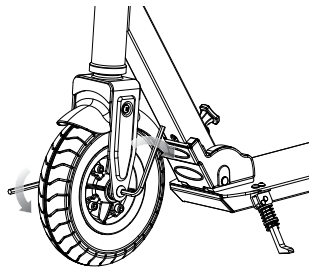

2 Securely tighten the bolt as shown.

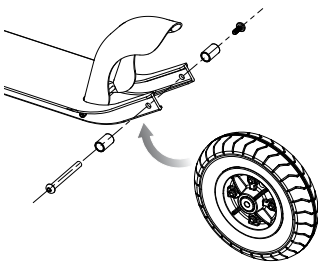

3 Rear wheel sequence.

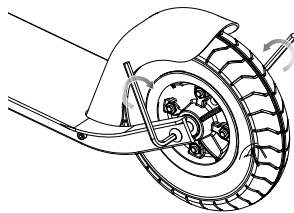

4 Securely tighten the bolt as shown.

Need Help? Visit our web site for replacement parts, product support, a list of authorized service centers in the US and customer service contact information at www.razor.com. Please have the product I.D. code (located on the white label of your product) available for better assistance. Additional Customer Service contact information is listed at the back of this manual.

WARRANTY

Razor Limited Warranty

The manufacturer warrants this product to be free of manufacturing defects for a period of 6 months from date of purchase. This Limited Warranty does not cover normal wear and tear, or any damage, failure or loss caused by improper assembly, maintenance, or storage.

This Limited Warranty will be void if the product is ever:

- used in a manner other than for recreation;
- modified in any way;
- rented.

The manufacturer is not liable for incidental or consequential loss or damage due directly or indirectly to the use of this product.

Razor does not offer an extended warranty. If you have purchased an extended warranty, it must be honored by the store at which it was purchased.

For your records, save your original sales receipt with this manual and write the serial number below.

CUSTOMER SERVICE CONTACT INFORMATION

Need Help? Visit our web site for replacement parts, product support, a list of authorized service centers in the US and customer service contact information at www.razor.com. Please have the product I.D. code (located on the white label of your product) available for better assistance. Additional Customer Service contact information is listed below:

AMERICAS

Razor USA LLC
P.O. Box 3610
Cerritos, CA 90703
USA

+1 866 467 2967
Monday - Friday
8:00 AM - 5:00 PM Pacific Time
customersupport@razorusa.com

DISTRIBUTED IN THE UK BY:

Re:creation Limited
2 Meadows Business Park
Station Approach, Blackwater
Camberley, Surrey GU17 9AB
United Kingdom

+44 (0) 118 973 6222 *Tel*
+44 (0) 118 973 6220 *Fax*
sales@recreationltd.co.uk

EUROPE

Razor USA LLC (Europe)
Handelsweg 2
2742 RD Waddinxveen
Netherlands

+44 (0) 120 267 2702

DISTRIBUTED IN AUSTRALIA BY:

Funtastic Limited
Level 2, Tower 2, Chadstone Place
1341 Dandenong Road
Chadstone VIC 3148
Australia

+1 800 244 543
info@funtastic.com.au

ASIA

Razor USA LLC (Asia)
P.O. Box 3610
Cerritos, CA 90703
USA

+81 50 7579 6622
info@razor-asia.com

Printed in China for:
Razor USA LLC
PO Box 3610
Cerritos, CA 90703

Copyright © 2003-2016 Razor USA LLC. All rights reserved. Razor, the Razor logo design, and A logo design are among the registered trademarks of Razor USA LLC in the United States and/or select foreign countries. A5 Air is a trademark of Razor USA LLC.