



E300

E300S



OWNER'S MANUAL

**Read and understand this entire manual before riding!
DO NOT RETURN TO STORE!**

**NOTE: Manual illustrations are for demonstration purposes only.
Illustrations may not reflect exact appearance of actual product.
Specifications subject to change without notice.**

CONTENTS

Safety Warnings	1	Repair and Maintenance	5-8
Before You Begin	2	Troubleshooting Guide	9
Assembly and Set-Up	3-4	Electric Scooter Parts	10
Hardware Maintenance	5	Warranty	12

SAFETY WARNINGS

⚠ WARNING: Riding the electric scooter can be a hazardous activity. Certain conditions may cause the equipment to fail without fault of the manufacturer. Like other electric products, the scooter can and is intended to move, and it is therefore possible to lose control, fall off and/or get into dangerous situations that no amount of care, instruction or expertise can eliminate. If such things occur you can be seriously injured or die, even when using safety equipment and other precautions. **RIDE AT YOUR OWN RISK AND USE COMMON SENSE.**

This manual contains many warnings and cautions concerning the consequences of failing to maintain, inspect or properly use your electric scooter. Because any incident can result in serious injury or even death, we do not repeat the warning of possible serious injury or death each time such a possibility is mentioned.

APPROPRIATE RIDER USE AND PARENTAL SUPERVISION

This manual contains important safety information. It is your responsibility to review this information and make sure that all riders understand all warnings, cautions, instructions and safety topics and assure that young riders are able to safely and responsibly use this product. Razor recommends that you periodically review and reinforce the information in this manual with younger riders, and that you inspect and maintain your children's scooter to insure their safety.

The recommended rider age is 13 and older. Any rider unable to fit comfortably on the scooter should not attempt to ride it. A parent's decision to allow his or her child to ride this product should be based on the child's maturity, skill and ability to follow rules.

Keep this product away from small children and remember that it is intended for use only by persons who are, at a minimum, completely comfortable and competent while operating the scooter.

DO NOT EXCEED THE WEIGHT LIMIT OF 220 pounds (100kg). Rider weight does not necessarily mean a person's size is appropriate to fit or maintain control of the scooter.

Do not touch the brakes or motor on your scooter when in use or directly after use as these parts can become very hot.

ACCEPTABLE RIDING PRACTICES AND CONDITIONS

Always check and obey any local laws or regulations which may affect the locations where the electric scooter may be used.

Ride defensively. Watch out for potential obstacles that could catch your wheel or force you to swerve suddenly or lose control. Be careful to avoid pedestrians, skaters, skateboards, scooters, bikes, children or animals who may enter your path, and respect the rights and property of others.

Do not activate the speed control on the hand grip unless you are on the scooter and in a safe, outdoor environment suitable for riding.

Do not attempt or do stunts or tricks on your electric scooter. This scooter is not made to withstand abuse from misuse such as jumping, curb grinding or any other type of stunts.

Maintain a hold on the handlebars at all times.

Never carry passengers or allow more than one person at a time to ride the scooter.

Never use near steps or swimming pools.

Keep your fingers and other body parts away from the chain, drive chain, steering system, wheels and all other moving components.

Never use headphones or a cell phone when riding.

Never hitch a ride with another vehicle.

Do not ride your scooter in wet or icy weather and never immerse the scooter in water, as the electrical and drive components could be damaged by water or create other possibly unsafe conditions.

The electric scooter is intended for use on flat, dry surfaces such as pavement or level ground without loose debris such as sand, leaves, rocks or gravel. Wet, slick, bumpy, uneven or rough surfaces may impair traction and contribute to possible accidents. Do not ride your scooter in mud, ice, puddles or water. Avoid excessive speeds that can be associated with downhill rides. Never risk damaging surfaces such as carpet or flooring by using the electric scooter indoors.

Do not ride at night or when visibility is limited.

PROPER RIDING ATTIRE

Always wear proper protective equipment such as an approved safety helmet (with chin strap securely buckled). A helmet may be legally required by local law or regulation in your area. Elbow and kneepads, a long-sleeved shirt, long pants, and gloves are recommended. Always wear athletic shoes (lace-up shoes with rubber soles), never ride barefooted or in sandals, and keep shoelaces tied and out of the way of the wheels, motor and drive system.

USING THE CHARGER

The charger supplied with the electric scooter should be regularly examined for damage to the cord, plug, enclosure and other parts, and in the event of such damage, the scooter must not be charged until the charger has been repaired or replaced.

Use only with the recommended charger.

Use caution when charging.

The charger is not a toy. Charger should be operated by an adult.

Do not operate charger near flammable materials.

Unplug charger and disconnect from scooter when not in use.

Do not exceed charging time.

Always disconnect from the charger prior to wiping down and cleaning your scooter with liquid.

FAILURE TO USE COMMON SENSE AND HEED THE ABOVE WARNINGS INCREASES RISK OF SERIOUS INJURY. USE WITH APPROPRIATE CAUTION AND SERIOUS ATTENTION TO SAFE OPERATION.

BEFORE YOU BEGIN

Remove contents from box. Remove the foam separators that protect the components from damage during shipping. Inspect the contents of the box for scratches in the paint, dents or kinked cables that may have occurred during shipping. Because the scooter is 95 percent assembled and packed at the factory, there should not be any problems, even if the box has a few scars or dents.

MAKE SURE POWER SWITCH IS TURNED "OFF" BEFORE CONDUCTING ANY ASSEMBLY OR MAINTENANCE PROCEDURES.

Estimated Assembly and Set-Up Time

Allow up to 20 minutes for assembly, not including initial charge time.

Allow up to 18 hours for initial charge (see page 3 for charging information)

WARNING:
DO NOT USE NON-RAZOR PRODUCTS WITH YOUR RAZOR ELECTRIC SCOOTER. The scooter has been built to certain Razor design specifications. The original equipment supplied at the time of sale was selected on the basis of its compatibility with the frame, fork and all other parts. Certain aftermarket products may or may not be compatible.

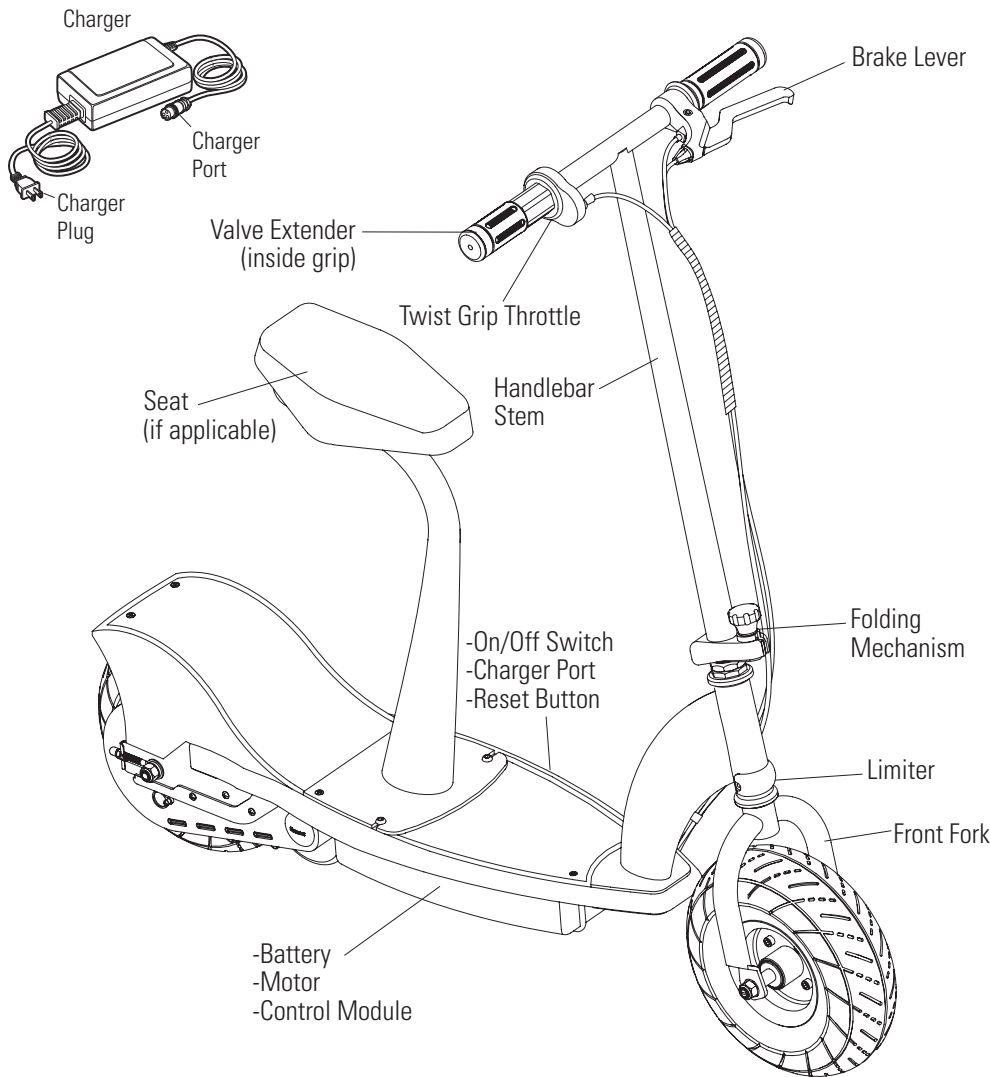

Required Tools

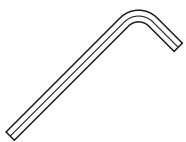

6mm key wrench
(Included)
4mm key wrench
(Included)
(300S ONLY)

2.5mm/5mm key wrenches
(Not Included)



8mm/10mm/17mm
wrenches
(Not Included)

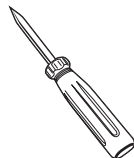

Phillips
screw driver
(Included)
(300S ONLY)

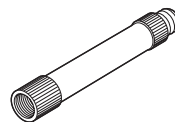

Valve extender
**(Located in right
handlebar grip)**

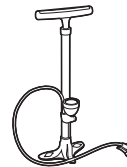

Bicycle-style tire pump
for Schrader valve tires,
with pressure gauge
(Not Included)

Need Help? Visit our web site for replacement parts, product support and a list of authorized service centers at www.razor.com or call toll-free at 866-467-2967 Monday - Friday 8:00AM - 5:00PM Pacific Time.

ASSEMBLY AND SET-UP

□ Attaching the Handlebars

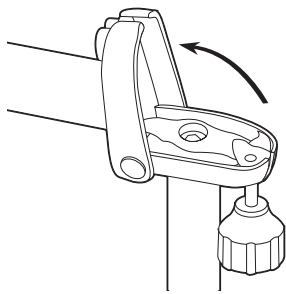

1 Loosen the locking knob and swing to the 6 o'clock position to unfold the handlebar.

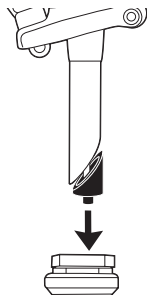

2 Remove the plastic protector covering the base of the handlebar assembly. Insert the "quill" part of the handlebar assembly into the fork. You may have to loosen the wedge to allow it to slip into the fork.

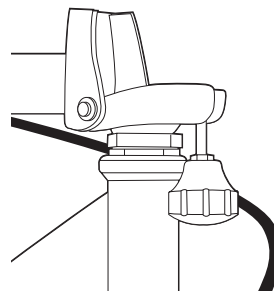

3 Slide the quill into the fork until it bottoms on the headset.

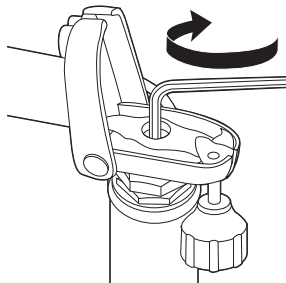

4 Using a 6mm hexagonal key wrench, tighten the wedge by turning the bolt clockwise. The wedge is properly tightened when the handlebars cannot be twisted out of alignment with the front wheel.

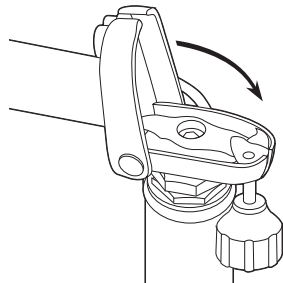

5 Pivot the handlebar assembly upright.

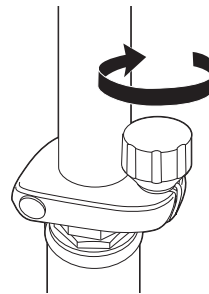

6 Swing the locking knob to the 12 o'clock position and tighten by hand as firmly as possible.

□ Inflating the Tires

Tires are inflated when shipped, but they invariably lose some pressure between the point of manufacturing and your purchase. **Always inflate tires to the correct PSI before first time use.**

Rear Tire

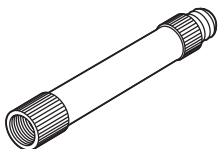

1 Use the valve extender located inside the end of the right handlebar grip.

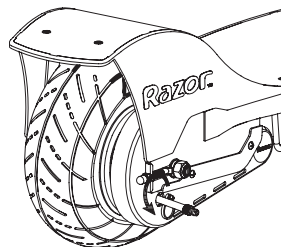

2 Open the round cover located on the chain cover by sliding the cover upward. Align the opening in the drive sprocket with the valve stem. Thread the adapter completely onto the valve stem and attach the pump. Inflate to the PSI indicated on the tire sidewall.

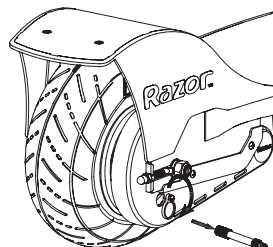

3 Remove valve extender immediately after inflating and close the round cover.

Note: Make sure the cables/wires are out of the way before inserting the stem in the fork.

⚠ WARNING: Failure to properly tighten the wedge may allow the handlebars to dislodge while riding and may cause you to lose control and fall. When correctly tightened, the handlebars will not rotate out of alignment with the front wheel under normal circumstances.

⚠ WARNING: Keep your fingers clear of the pivoting mechanism when folding or unfolding the scooter, and make sure others are standing clear.

Note: The cable and wire assembly from the handlebar must not wrap around the steering tube or handlebar as shown in step 3. Sharp bends or twisting of the brake cable can cause the brakes to malfunction.

⚠ WARNING: Failure to remove the valve adapter after inflating will cause the inner tube and/or adapter to be severed by the rear drive sprocket.

Note: If you lose the valve extender, one can be purchased at almost any auto parts store.

Note: The pressurized air supplies found at gasoline stations are designed to inflate high-volume automobile tires. If you decide to use such an air supply to inflate your electric scooter tires, first make sure the pressure gauge is working, then use very short bursts to inflate to the correct PSI. If you inadvertently over-inflate the tire, release the excess pressure immediately.

ASSEMBLY AND SET-UP

Front Tire

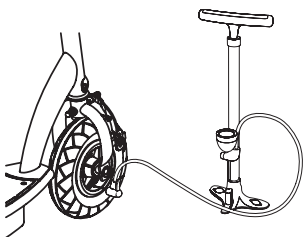

4 Using a bicycle style tire pump equipped for a Schrader-type valve, inflate the front tire to the PSI indicated on the sidewall of the tire.

□ Attaching the Seat (if applicable)

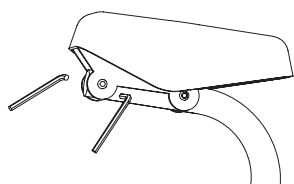

1 Attach the seat to the seat post with two 4mm key wrenches.

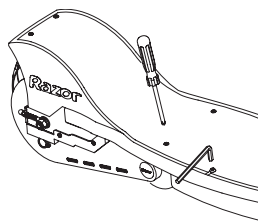

2 Unscrew the four screws on the middle of the deck with the 4mm key wrench and the Phillips screwdriver.

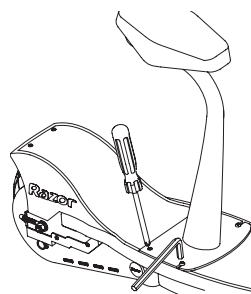

3 Place the seat post on the deck and secure using the same 4 screws.

Note: Do not completely tighten at this time. Adjust the seat tilt approximately level to the ground, or slightly tilted depending on your personal preference. Tighten securely. The seat tilt adjustment should not move when riding.

□ Charging the Battery

Your electric scooter may not have a fully charged battery. Therefore it is a good idea to charge the battery prior to use.

- Initial charge time: 18 hours
 - Recharge time: up to 12 hours
 - Run time: Up to 40 minutes of continuous ride time
 - Average battery life: 250 charge/discharge cycles
- When the scooter is not in regular use, recharge the battery at least once a month until normal use is resumed.

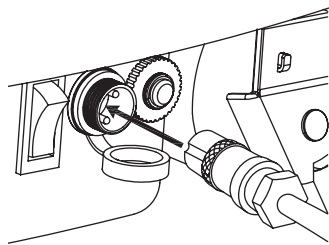
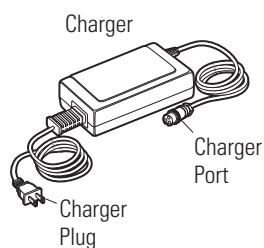

1 Turn **OFF** power switch before charging. Plug the charger into the charger port on the electric scooter.

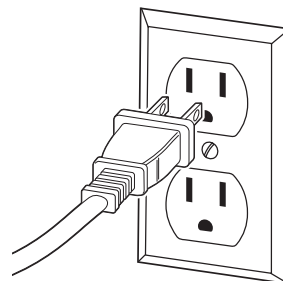

2 Plug the charger into a wall outlet. If the lights on charger do not light up, check the power to the outlet. If necessary, try a different outlet.

⚠ WARNING: Always disconnect your scooter from the charger before cleaning with liquid.

Note: If your charger does not look like the one illustrated, your unit has been supplied with an alternative charger. The specifications and charging procedure would not change.

The charger has a small window with one LED or two LEDs to indicate the charge status. Refer to the illustration on the charger unit for the actual "charging" and "charged" status indications for your model charger.

Chargers have built-in over-charge protection to prevent battery from being over-charged.

Charger will get warm during use. This is normal for some chargers and is no cause for concern. If your charger does not get warm during use, it does not mean that it is not working properly.

⚠ WARNING: Failure to recharge the battery at least once a month may result in a battery that will no longer accept a charge.

Need Help? Visit our web site for replacement parts, product support and a list of authorized service centers at www.razor.com or call toll-free at 866-467-2967 Monday - Friday 8:00AM - 5:00PM Pacific Time.

CONNECTORS/HARDWARE MAINTENANCE



Brake

Check the brakes for proper function. When you squeeze the lever, the brake should provide positive braking action. When you apply the brake with the speed control on, the brake cut-off switch should stop the motor. Make sure that brakes are not rubbing.



Frame, Fork and Handlebars

Check for cracks or broken connections. Although broken frames are rare, it is possible for an aggressive rider to run into a curb or wall and wreck and bend or break a frame. Get in the habit of inspecting your scooter on a regular basis.



Tires

Periodically inspect the tires for excess wear, and regularly check the tires pressure and re-inflate as necessary.



Safety Gear

Always wear proper protective gear such as an approved safety helmet. Elbow pads and kneepads are recommended. Always wear athletic shoes (lace-up shoes with rubber soles), never ride barefooted or in sandals, and keep shoelaces tied and out of the way of the wheels, motor and drive system.



Battery

Make sure the power switch is turned off whenever the scooter is not in use. Never store the product in freezing or below freezing temperatures! Freezing will permanently damage the battery.



Do not use this product for the first time until you have inflated the tires to the correct PSI and charged the battery for at least 18 hours.

Failure to follow these instructions may damage your product and void your warranty.

REPAIR AND MAINTENANCE

Turn power switch "OFF" before conducting any maintenance procedures.

Adjusting the Brakes

Tools required: 10mm open wrench

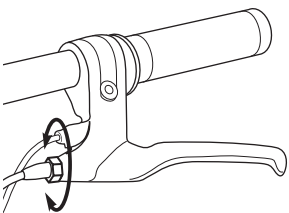

1 To adjust the brake cable play, thread the brake lever adjuster in or out 1/4 to 1/2 turn until the desired brake adjustment is attained. Most adjustments are complete at this step. If brake still needs further adjustment, proceed to step 2.

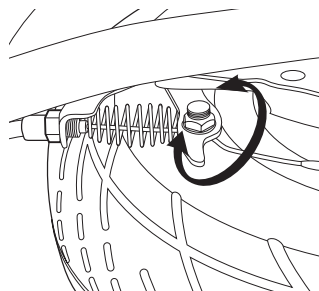

2 If the brake is too tight or too loose, use a 10mm open wrench to loosen the nut for additional adjustment on the brake cable. Securely tighten the nut when finished.

WARNING:

The brake is capable of skidding the rear tire and throwing an unsuspecting rider. Practice in an open area free from obstacles until you are familiar with the brake function. Avoid skidding to a stop as this can cause you to lose control and/or damage the rear tire.

REPAIR AND MAINTENANCE

Chain and Rear Tire Replacement

Tools required: Phillips screwdriver, 10mm wrench, two (2) 8mm wrenches, and two (2) 17mm wrenches.

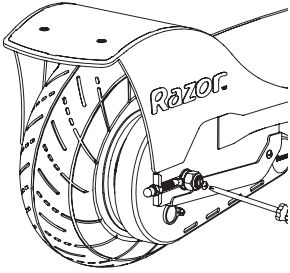

1 With a Phillips screwdriver, loosen the two screws and remove the chain guard.

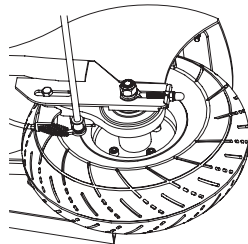

2 With a 10mm wrench, loosen the brake cable anchor and disconnect the cable.

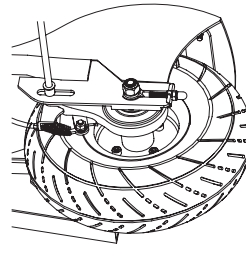

3 With two 8mm wrenches, loosen brake housing anchor and disconnect. Keep the spacer and bolts together.

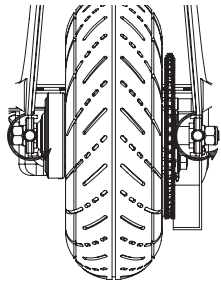

4 With a 10mm wrench, loosen both axle adjusters an equal amount, approximately five turns.

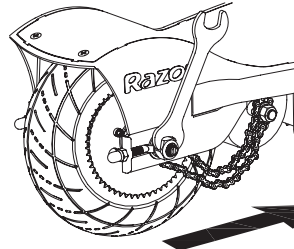

5 With two 17mm wrenches, loosen the axle. Slide the wheel forward to loosen the chain.

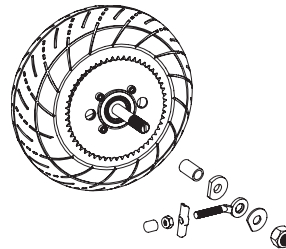

6 Remove wheel. Note the sequence of the hardware.

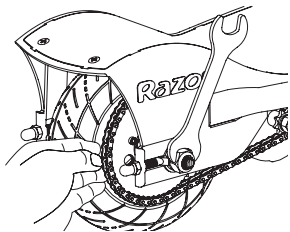

7 Install new chain or wheel by maneuvering the chain onto the sprocket and slipping the axle into the slots on the frame.

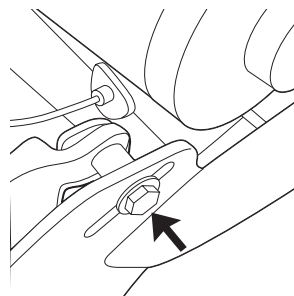

8 To hook up the brake housing anchor, align the cable guide adjuster and install the spacer and bolt. Do not tighten until final step.

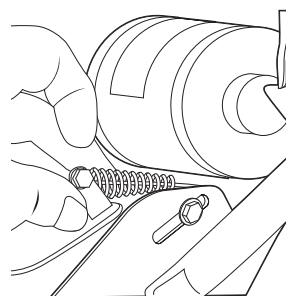

9 Install the brake spring and thread the cable wire into the cable anchor. Thread the cable to its original position and tighten securely.

Right Side (Throttle)

(Long) spacer
Washer (thick)
Washer (plate cut)
Axle adjusting eye
Locknut

Left Side (Brake)

Spacer (medium)
Brake plate
Spacer (small)
Washer (thick)
Washer (plate cut)
Axle adjusting eye
Locknut

Need Help? Visit our web site for replacement parts, product support and a list of authorized service centers at www.razor.com or call toll-free at 866-467-2967 Monday - Friday 8:00AM - 5:00PM Pacific Time.

REPAIR AND MAINTENANCE

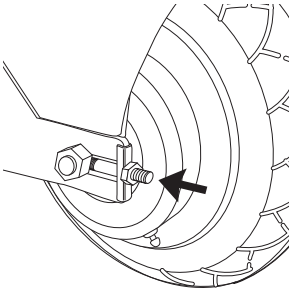

10 Install the axle adjusters and axle nuts. Tighten until they just barely hold the hardware in place.

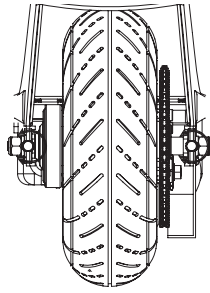

11 Tighten both axle adjusters the same number of turns to fine-tune the tension on the chain and center the wheel.

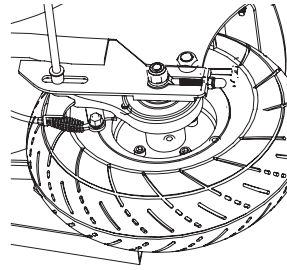

12 Tighten the brake housing anchor securely. Test ride. Readjust as needed.

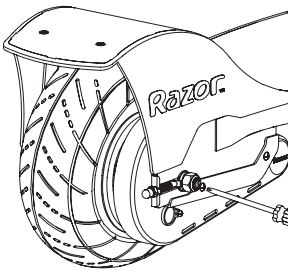

13 Replace the chain guard.

□ Front Tire Replacement

Tools required: two (2) 17mm wrenches and a flathead screwdriver.

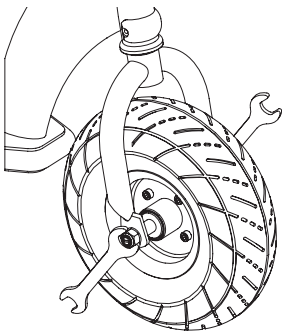

1 Using two 17mm wrenches, loosen the front axle bolts by turning the wrenches counter clockwise.

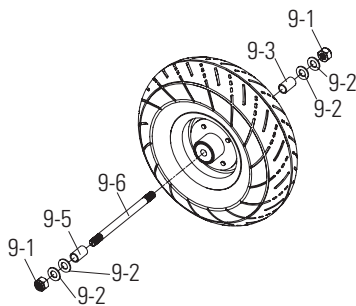

2 Remove wheel and install replacement.

Right Side (Throttle)

- 9-3 - Spacer
- 9-2 - Washer
- 9-2 - Washer
- 9-1 - 17mm locknut

Middle

- 9-6 - Front axle bolt

Left Side (Brake)

- 9-5 - Spacer
- 9-2 - Washer
- 9-2 - Washer
- 9-1 - 17mm locknut

REPAIR AND MAINTENANCE

□ Adjusting the Chain

Tools required: 10mm wrench, two (2) 8mm wrenches, and two (2) 17mm wrenches.

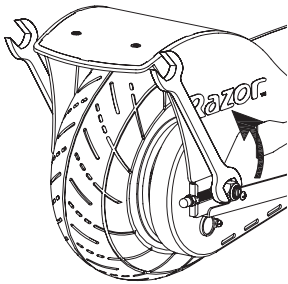

1 Using two 17mm wrenches, loosen the rear axle bolts by turning the wrenches counter clockwise.

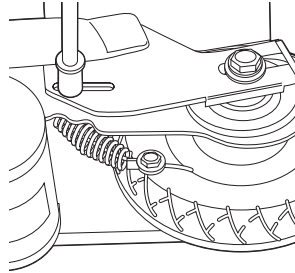

2 Using two 8mm wrenches, loosen the brake housing anchor bolt which is located in the long slot on the left side of the rear fork.

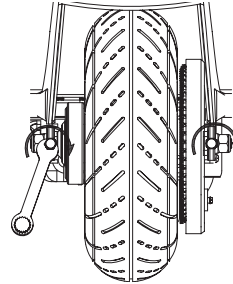

3 Using a 10mm wrench, tighten the tension adjusters on the axle 1/8 to 1/4 turn to fine-tune the chain tension. Both adjusters must be tightened the exact same amount to maintain wheel alignment.

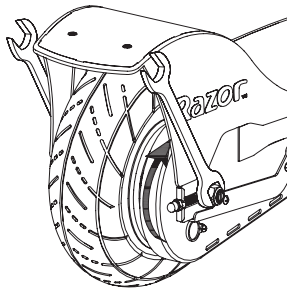

4 Once the tension is correct, tighten the axle bolts and brake housing anchor bolt. Test ride the scooter. Readjust as needed.

□ Battery Care and Disposal

Do not store the battery in temperatures above 75° or below -10° F.



CONTAINS SEALED LEAD ACID BATTERIES. BATTERIES MUST BE RECYCLED.

Disposal: Your Razor product uses sealed lead-acid batteries which must be recycled or disposed of in an environmentally safe manner. Do not dispose of a lead-acid battery in a fire. The battery may explode or leak. Do not dispose of a lead-acid battery in your regular household trash. The incineration, land filling or mixing of sealed lead-acid batteries with household trash is prohibited by law in most areas. Return exhausted batteries to a federal or state approved lead-acid battery recycler or a local seller of automotive batteries. If you live in Florida or Minnesota, it is prohibited by law to throw away lead-acid batteries in the municipal waste stream.

□ Charger

The charger supplied with the electric scooter should be regularly examined for damage to the cord, plug, enclosure and other parts and in the event of such damage, the product must not be charged until it has been repaired or replaced.

Use ONLY with the recommended charger.

□ Wheels

Wheels and drive system are subject to normal wear and tear. It is the responsibility of the user to periodically inspect wheels for excess wear and adjust and replace drive train components as required.

□ Replacement Parts

The most frequently requested replacement parts are available for purchase at some Razor retail partners. For the complete selection of replacement parts visit www.razor.com/shop.

□ Repair Centers

For a list of authorized Razor repair centers:

- Check online at www.razor.com.
- Call 866-467-2967 for the center nearest you.

Note: This system of adjusters is common to motorcycles and BMX bicycles. If you are not familiar with it or do not feel comfortable performing the adjustment, consult an authorized Razor service center or a qualified BMX bike or motorcycle mechanic.

The chain should be “just taut” – in other words snug, but not piano-wire tight. The tension should be similar to the fan chain on an automobile. BE CAREFUL NOT TO ADJUST TOO TIGHT. The tensioning system can easily impart too much tension and snap the chain or bend the motor shaft. Adjust 1/8 to 1/4 turn at a time and check the tension each time.

⚠ WARNING: If a battery leak develops, avoid contact with the leaking acid and place the damaged battery in a plastic bag. Refer to the disposal instructions at left. If acid comes into contact with skin or eyes, flush with cool water for at least 15 minutes and contact a physician.

⚠ WARNING: Battery posts, terminals and related accessories contain lead and lead compounds. **Wash your hands after handling.**

TROUBLESHOOTING GUIDE

Problem	Possible Cause	Solution
Scooter does not run	Undercharged battery	<p>Charge the battery. A new battery should be charged for at least 18 hours before using the scooter for the first time and up to 12 hours after each subsequent use.</p> <p>Check all connectors. Make sure the charger connector is tightly plugged into the charging port, and that the charger is plugged into the wall.</p>
Scooter suddenly stopped working while in use	Tripped circuit breaker	<p>Check all wires and connectors to make sure they are tight.</p> <p>The circuit breaker (next to on/off switch) will automatically shut off the power if the motor is overloaded.</p> <p>An excessive overload, such as too heavy a rider or too steep a hill, could cause the motor to overheat. If the scooter suddenly stops running, wait a few seconds and then push the breaker to reset the circuit. Correct the conditions that caused the breaker to trip and avoid repeatedly tripping the breaker.</p>
Short run time (less than 15 minutes per charge)	Undercharged battery	<p>Charge the battery. A new battery should be charged for at least 18 hours before using the scooter for the first time and up to 12 hours after each subsequent use.</p> <p>Check all wires and connectors. Make sure the battery connector is tightly plugged into the charger connector, and that the charger is plugged into the wall.</p>
	Battery is old and will not accept full charge	<p>Make sure power flow to the wall outlet is on.</p> <p>Even with proper care, a rechargeable battery does not last forever. Average battery life is 1 to 2 years depending on scooter use and conditions. Replace only with a Razor replacement battery.</p>
	Brakes are not adjusted properly	Refer to adjusting the brakes instructions on page 5.
Scooter runs sluggishly	Riding conditions are too stressful	Use only on solid, flat, clean and dry surfaces such as pavement or level ground.
	Tires are not properly inflated	The tires are inflated when shipped, but they invariably will lose some pressure between the point of manufacturing and your purchase. Refer to instructions on page 3 of this manual to properly inflate tires.
	Scooter is overloaded	Make sure you do not overload the electric scooter by allowing more than one rider at a time, exceeding the 220 lbs. (100kg.) maximum weight limit, going up a hill or towing objects behind the scooter. If the scooter is overloaded, the circuit breaker may trip and shut off power to the motor. Correct the riding conditions that caused the overload, wait a few seconds, and then push the breaker to reset the circuit. Avoid repeatedly tripping the circuit breaker.
	Brake dragging	Adjust brake at lever (page 5) to allow wheel to spin without brake contact.
Sometimes the scooter doesn't run, but other times it does	Brakes are not adjusted properly	Refer to adjusting the brakes instructions on page 5.
	Loose wires or connectors	Check all wires around the motors and all connectors to make sure they are tight.
Scooter makes loud noises or grinding sounds	Motor or electrical switch damage	Contact your local Razor authorized service center for diagnosis and repair.
	Chain is too dry	Apply a lubricant such as 3 in 1™ or Tri-Flow™ to the chain.

E300 / E300S SCOOTER PARTS

Keep your scooter running for years with genuine Razor parts. Visit our web site or e-mail us for more information on spare part availability. (Specifications subject to change without notice.)

1	Handlebar grips (right/left)	7	Front fork	15	Motor - 250W
1-1	Valve extender	8	Limiter	16	Kickstand
1-2	Handlebar end cap	9	Front wheel complete	17	Rear wheel complete
2	Single speed twist-grip throttle		(See page 7 for hardware sequence)		(See page 6 for hardware sequence)
2-1	Sleeve	10	Reset button	18	Chain
3	Handlebar stem	11	On/Off switch	19	Chain guard
4	Brake lever assembly	12	Charger port	20	Battery Bracket
5	Quick release lever	13	Control module	21	Deck plate w/grip tape
6	Headset (upper/lower)	14	Battery (2-12V/7Ah)	22	Seat with post (if applicable)

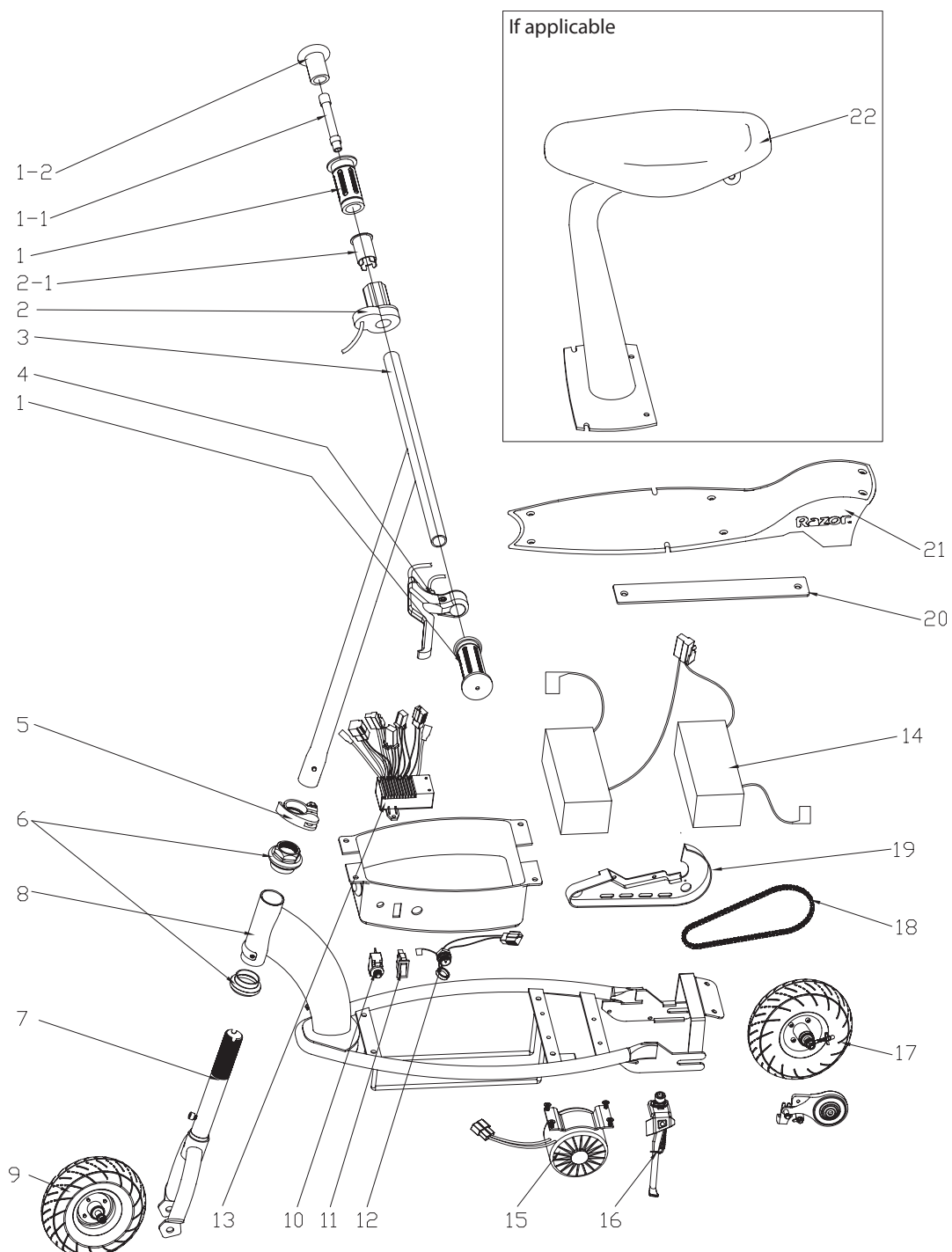

SB 1918 (CALIFORNIA) DECLARATION

YOUR INSURANCE POLICIES MAY NOT PROVIDE COVERAGE FOR ACCIDENTS INVOLVING THE USE OF THIS SCOOTER/ELECTRIC RIDE-ON PRODUCT. TO DETERMINE IF COVERAGE IS PROVIDED, YOU SHOULD CONTACT YOUR INSURANCE COMPANY OR AGENT.

WARRANTY

Razor Limited Warranty

The manufacturer warrants this product to be free of manufacturing defects for a period of 90 days from date of purchase. This Limited Warranty does not cover normal wear and tear, tires, tubes or cables, or any damage, failure or loss caused by improper assembly, maintenance, or storage or use of the Razor electric scooter.

This Limited Warranty will be void if the product is ever

- used in a manner other than for recreation or transportation
- modified in any way;
- rented.

The manufacturer is not liable for incidental or consequential loss or damage due directly or indirectly to the use of this product.

Razor does not offer an extended warranty. If you have purchased an extended warranty, it must be honored by the store at which it was purchased.

For your records, save your original sales receipt with this manual and write the serial number below.

Item Number:

E300	13113640
E300S	13116240
Sweet Pea	13116261

Community Design No. 130919-0001
U.S. Design Patent D497,397 S
U.S. Design Patent D513,629 S
Canadian Design Registration No. 105673

Printed in China for:
Razor USA LLC
PO Box 3610
Cerritos, CA 90703

Copyright © 2003-2010 Razor USA LLC. All rights reserved. RAZOR and the Razor Logo Design are among the registered trademarks of Razor USA LLC in the United States and/or select foreign countries.